

Bally®

SEA ISLAND

OPERATING INSTRUCTIONS AND PARTS CATALOG

Part Numbers are marked on illustrations
and a list of miscellaneous parts appears
on back cover.

**FOR QUICKEST SERVICE
STATE CORRECT PART NUMBER
WHEN ORDERING PARTS**

Code	
N.C. ___	Normally closed
N.O. ___	Normally open
M.B.B. ___	Make before break
S.P.D.T. ___	Single pole double throw

Home of Ballygames and Ballyrides

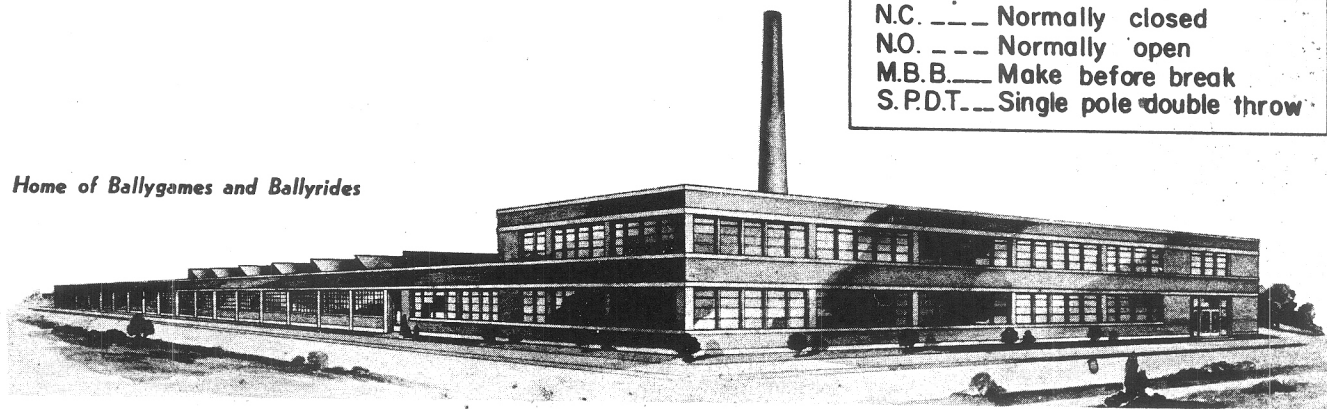

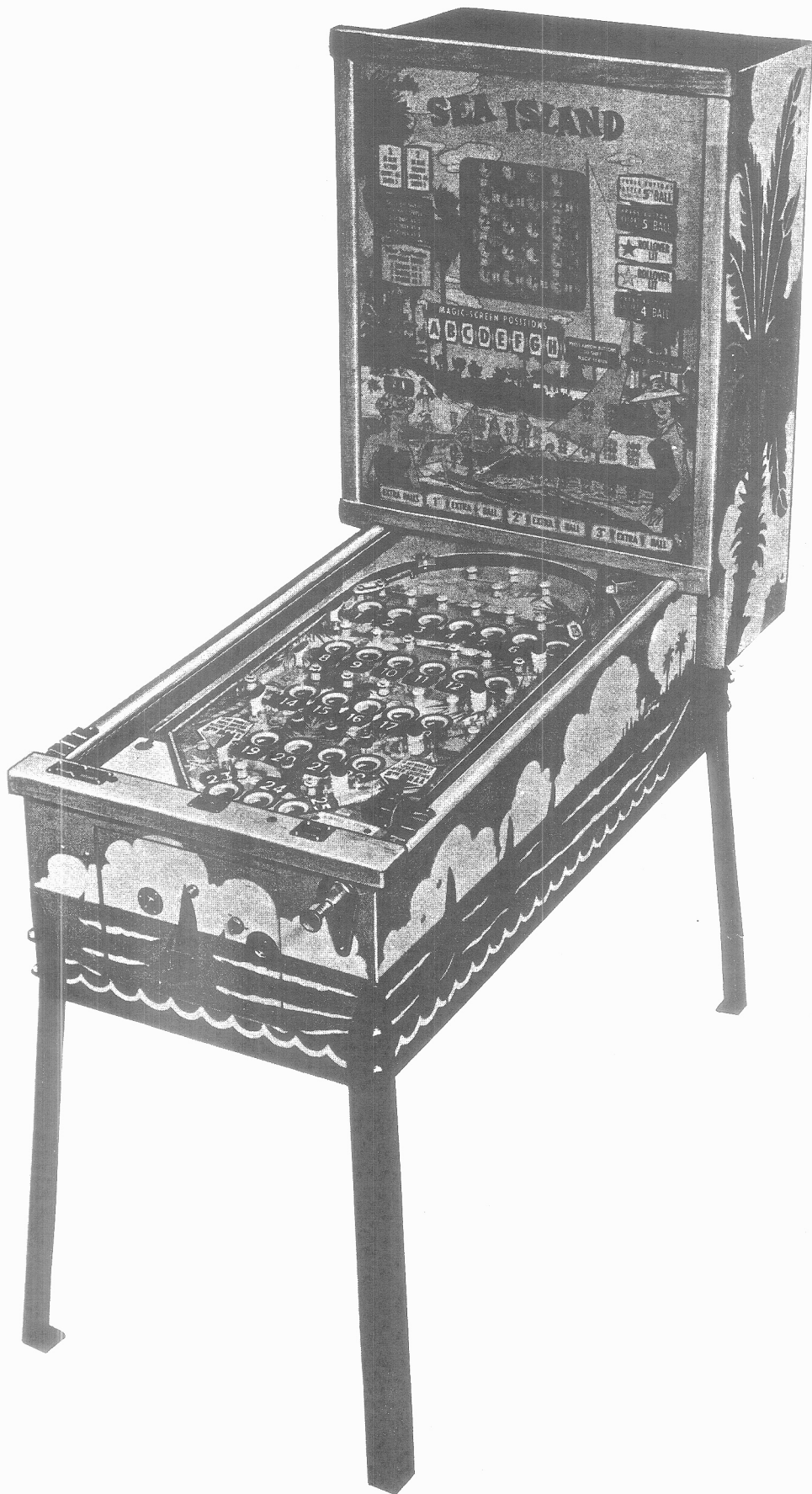

TIMER UNIT viewed from BUTTON or WIPER side

8 step unit. Wipers shown in zero or reset position

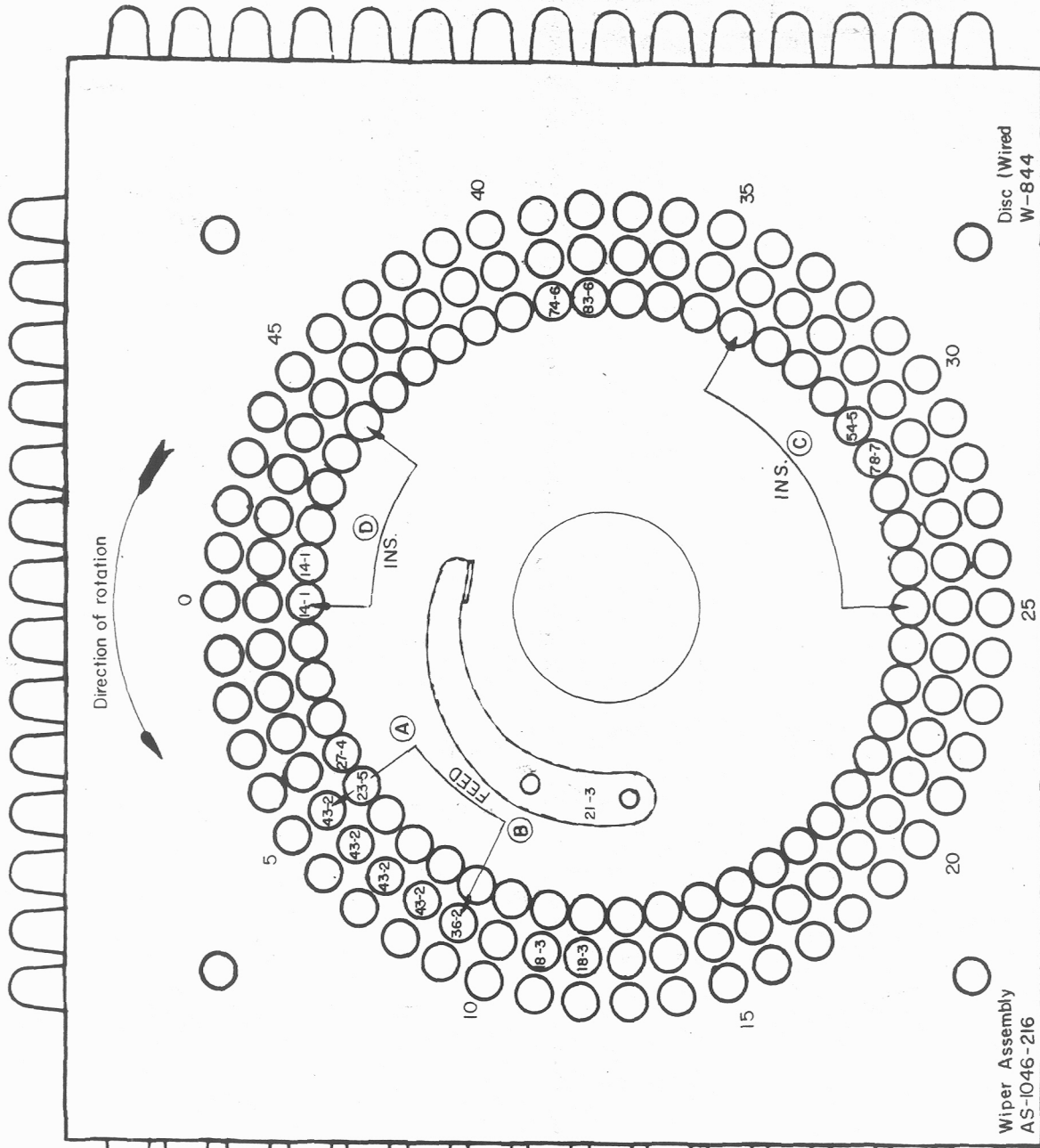

- Feed for wipers (D) — 14-1
- Thru wipers (D), circuit to flash select-now lite at 4th step. (Diag. K-1) — 27-4
- Thru wiper (A), circuit to step this unit 1st 4 steps. (Diag. H-7) — 43-2
- Thru feed ring, feed for wipers (A) & (B) — 21-3
- Thru wiper (B), circuit to close shutter at 2nd step of unit. (Diag. H-8) — 18-3
- Thru wipers (C), circuit to energize before 4th selector lock trip relay, when 4th ball is shot. (Diag. C-11) — 83-6
- Thru wipers (C), circuit to energize before 5th selector lock trip relay, when 5th ball is shot. (Diag. C-11) — 78-7
- Thru wipers (C), circuit to flash "select-now" lite at 5th step. (Diag. K-1) — 54-5
- Thru wiper (A), circuit to step unit from 4th to 5th step. (Diag. H-8) — 74-6
- Thru wiper (A), circuit to step unit from 4th to 5th step. (Diag. H-8) — 23-5
- Thru wiper (A), circuit to step unit from 4th to 5th step. (Diag. H-8) — 36-2

Complete unit --- AS-110-29
 Reset coil --- 28-R-15
 Step-up coil --- 25-GG-7
 Step-up plunger --- S-496-100
 Step-up arm --- A-1765-4
 Ratchet & shaft --- C-1050-8-41

RED SCORE UNIT viewed from **BUTTON** or **WIPER** side

8 step unit. Wipers shown in zero or reset position

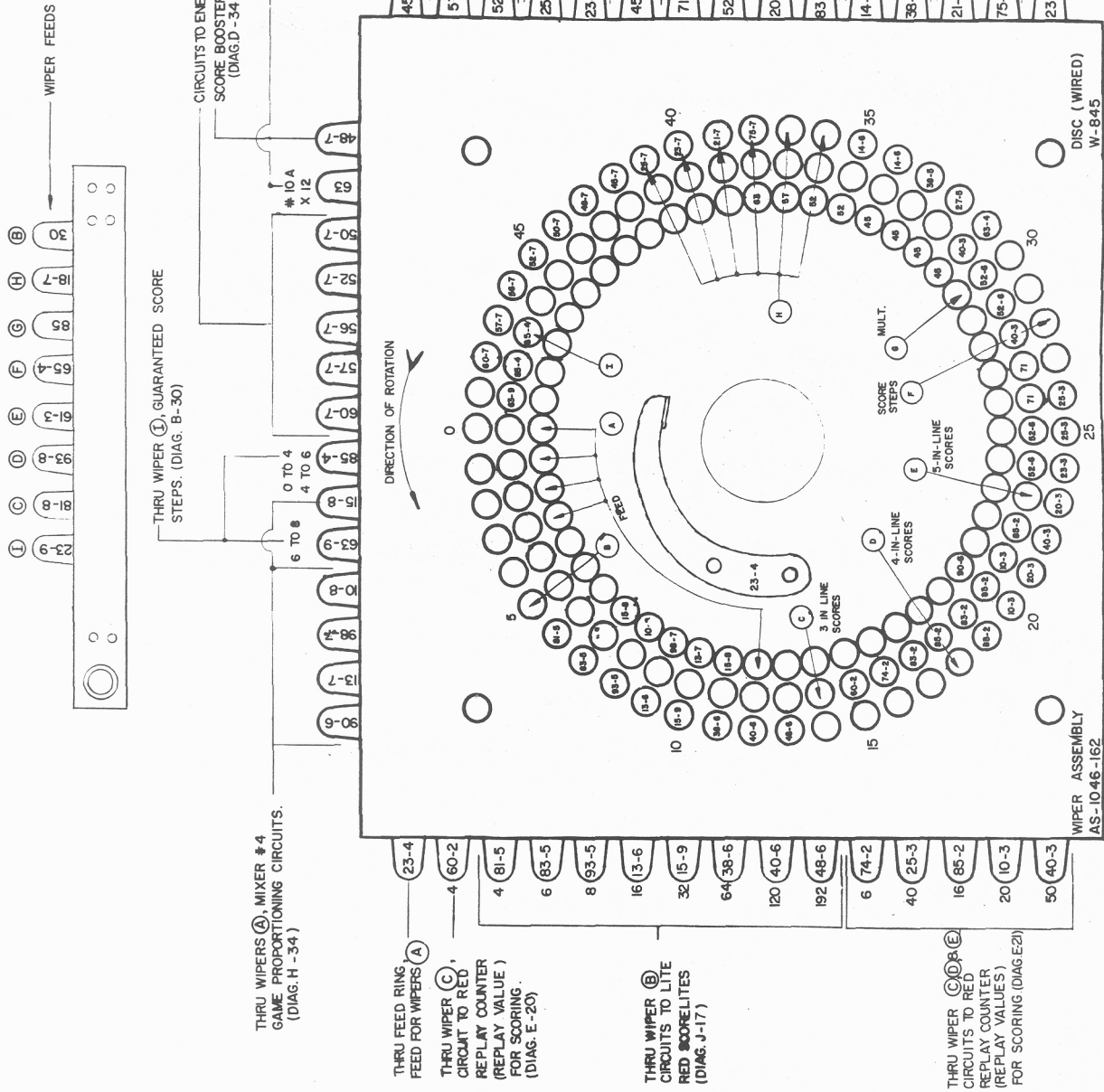

- COMPLETE UNIT — AS-1022-45
- RESET COIL — 28-R-15
- STEP-UP COIL — 25-GG-7
- STEP-UP PLUNGER — S-496-100
- STEP-UP ARM — A-1765-8
- RATCHET & SHAFT — C-1050-8-39

- 8 TO 16
- 16 TO 32

THRU WIPER (F) SCORE STEPS
THRU MIXER #3 (DIAG. C-29)

THRU WIPER (D), GUARANTEED SCORE STEPS. (DIAG. B-30)

THRU WIPERS (A), MIXER #4 GAME PROPORTIONING CIRCUITS. (DIAG. H-34)

THRU FEED RING FEED FOR WIPERS (A)

THRU WIPER (C) CIRCUIT TO RED REPLAY COUNTER (REPLAY VALUE) FOR SCORING. (DIAG. E-20)

THRU WIPER (B) CIRCUITS TO LITE RED SCORELITES (DIAG. J-17)

THRU WIPER (D), (E) CIRCUITS TO RED REPLAY COUNTER (REPLAY VALUES) FOR SCORING (DIAG. E-21)

CIRCUITS TO ENERGIZE RED OR YELLOW SCORE BOOSTER RE. THRU WIPERS (H) (DIAG. D-34)

CIRCUITS TO MULT. CAM SW'S TO PULSE RED REPLAY COUNTER, WHEN SCORING. THRU WIPER (G) (DIAG. B-23)

CIRCUITS TO ENERGIZE RED OR YELLOW SCORE BOOSTER RE. THRU WIPERS (H) (DIAG. D-34)

THRU WIPER (C), (D), (E) CIRCUITS TO RED REPLAY COUNTER (REPLAY VALUES) FOR SCORING. (DIAG. E-21)

THRU WIPER (F) SCORE STEPS THRU MIXER #3 (DIAG. D-29)

CIRCUITS TO ENERGIZE RED OR YELLOW SCORE BOOSTER RE'S. THRU WIPERS (H) (DIAG. D-34)

THRU WIPER (D) CIRCUIT TO RED REPLAY COUNTER (REPLAY VALUE) FOR SCORING. (DIAG. E-21)

CIRCUITS TO ENERGIZE RED OR YELLOW SCORE BOOSTER RE. THRU WIPERS (H) (DIAG. D-34)

#11A X6

#12A X4

#13A X1

OPEN AT 96 SW.

52-6 75

20-3 24

83-2 8

64 TO 120

120 TO 192

38-5 32 TO 64

21-7

75-7

23-3 36

- (L) 9
- (C) 18
- (D) 8
- (E) 16
- (F) 5
- (G) 18
- (H) 18
- (B) 30

WIPER FEEDS

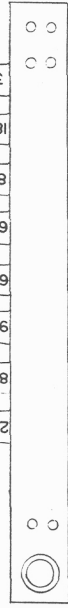

YELLOW SCORE UNIT viewed from BUTTON or WIPER side

8 step unit. Wipers shown in zero or reset position

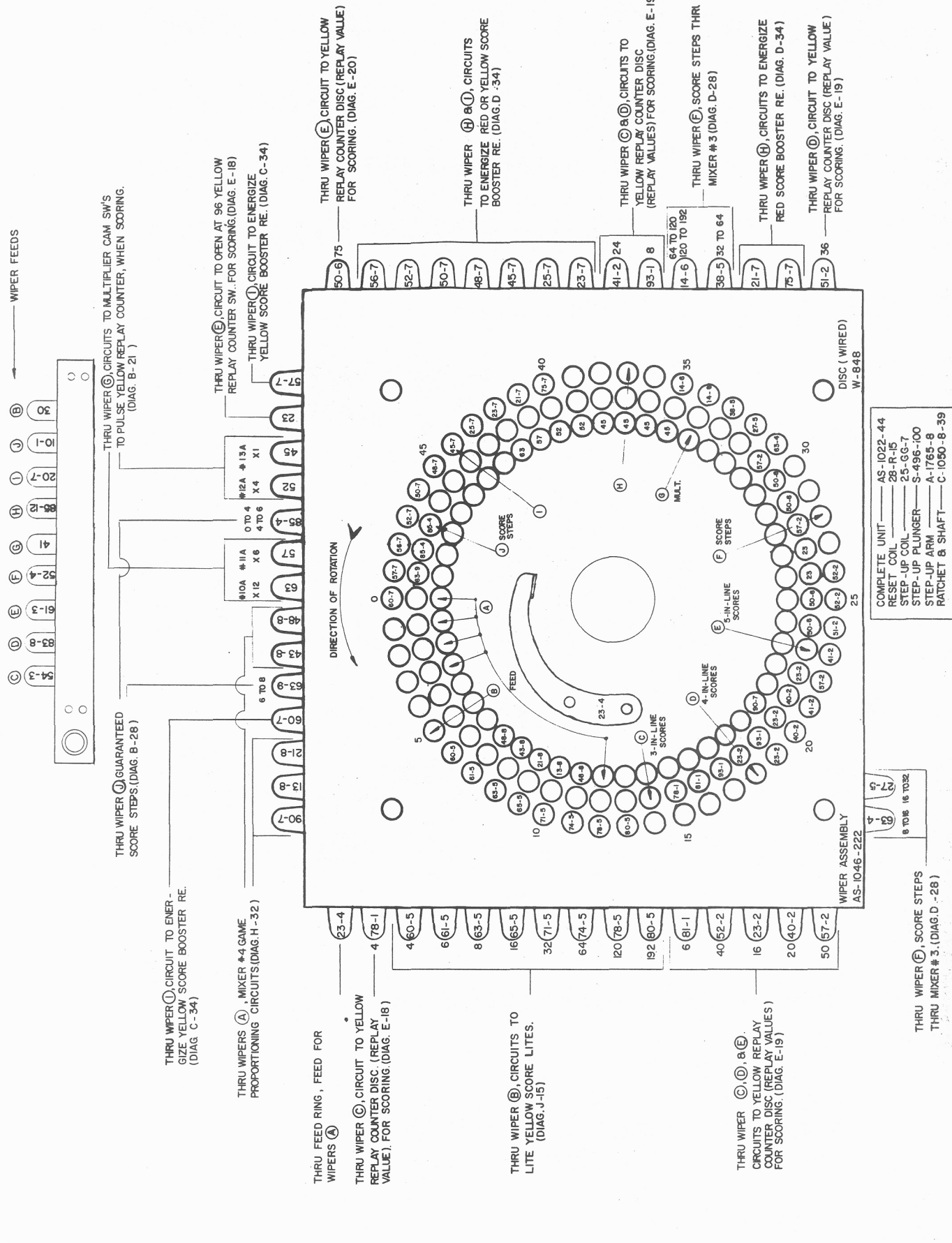

- COMPLETE UNIT
- AS-1022-44
 - RESET COIL
 - 28-R-15
 - STEP-UP COIL
 - 25-GG-7
 - STEP-UP PLUNGER
 - S-496-100
 - STEP-UP ARM
 - A-1765-8
 - RATCHET & SHAFT
 - C-1050-8-39

THRU WIPER (E), SCORE STEPS
THRU MIXER #3. (DIAG. D-28)

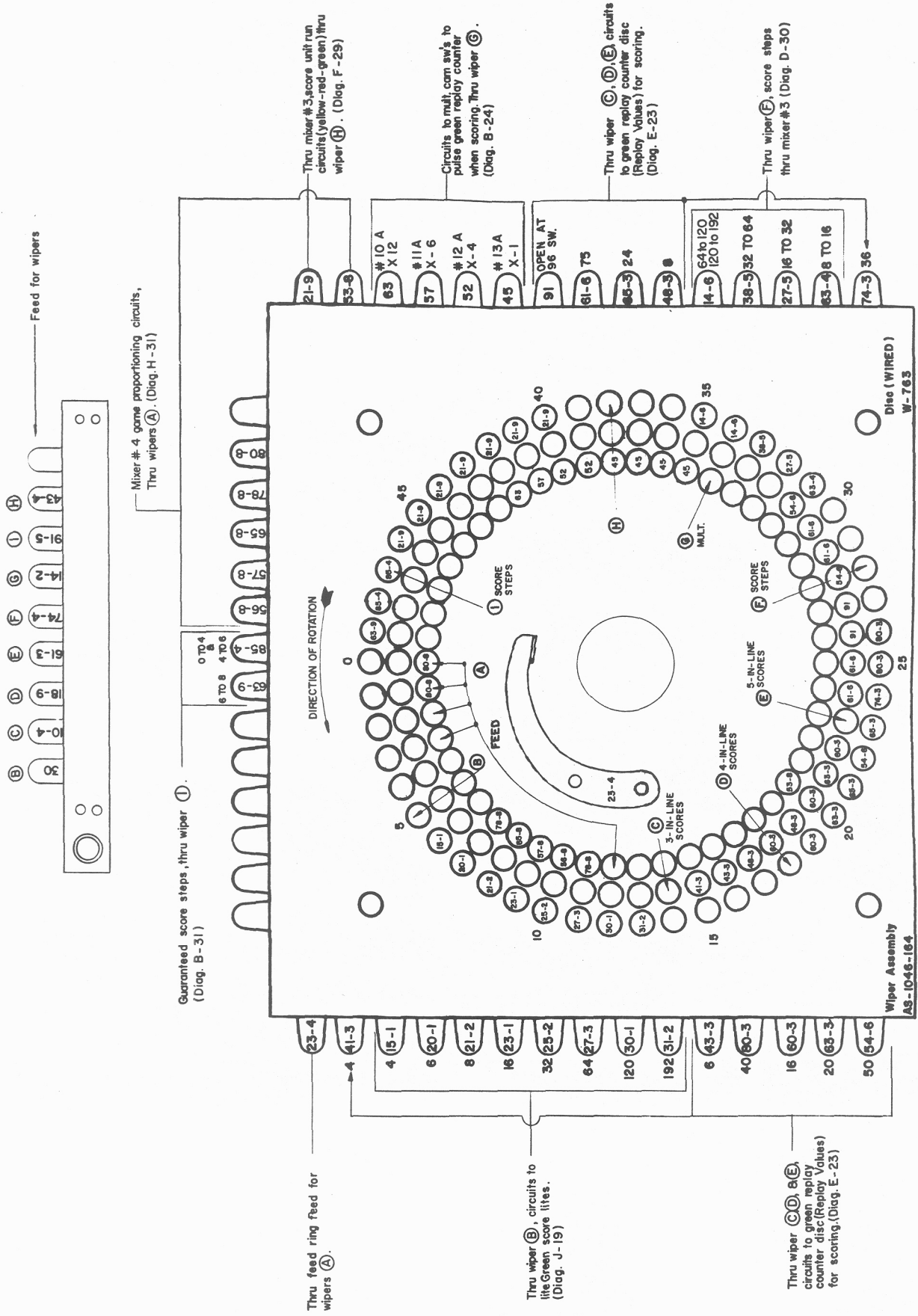

Complete Unit	AS-1022-32
Reset Coil	28-R-15
Step-Up Coil	25-GG-7
Step-Up Plunger	S-496-100
Step-Up Arm	A-1765-8
Ratchet & Shaft	C-1050-8-39

EXTRA BALL UNIT viewed from BUTTON or WIPER side

10 step unit. Wipers shown in zero or reset position

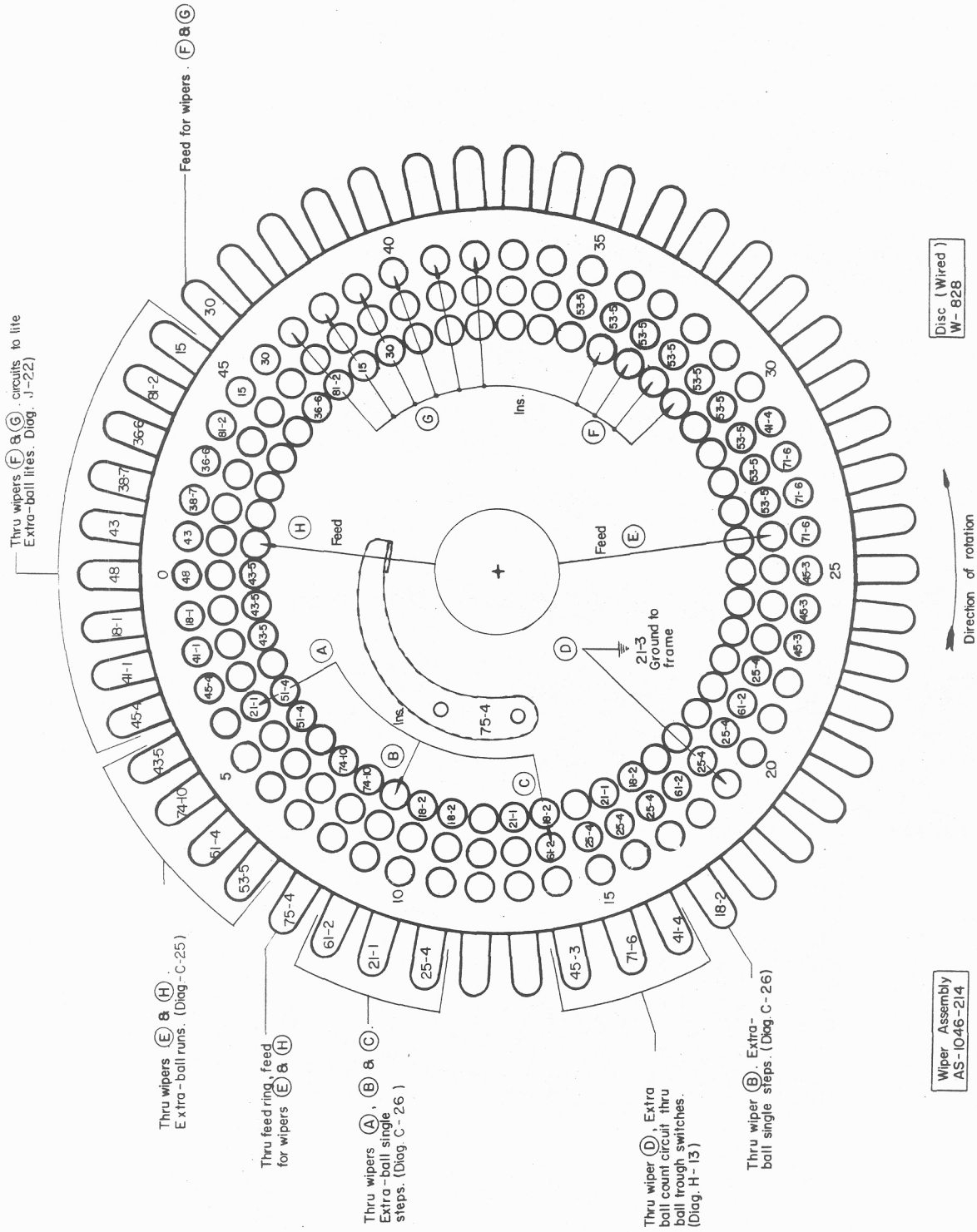

- Complete unit --- AS-1148-16
- Reset coil --- 28-R-15
- Step-up coil --- 25-GG-7
- Step-up plunger --- S-496-100
- Step-up arm --- A-1765-4
- Ratchet & shaft --- C-1050-10

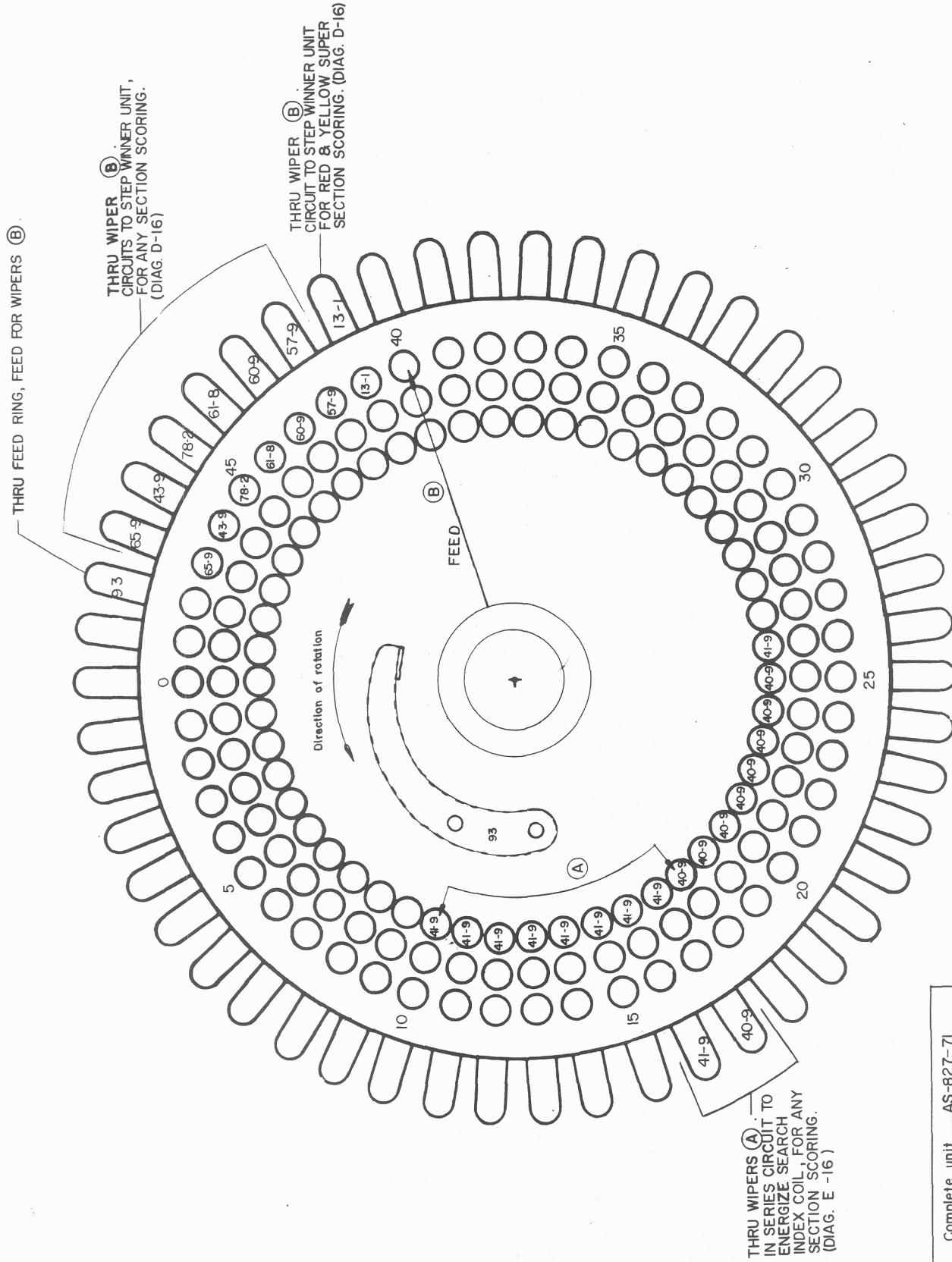

THRU WIPERS (A) IN SERIES CIRCUIT TO ENERGIZE SEARCH INDEX COIL FOR ANY SECTION SCORING. (DIAG. E-16)

Complete unit...AS-827-71
 Reset coil...28-R-15
 Step-up coil...E-184-121
 Step-up arm...A-1765-4
 Step-up plunger...S-496-100
 Ratchet & shaft...C-1050-8-40

Wiper Assembly
 AS-1046-224

Disc (Wired)
 W-847

MAGIC SCREEN FEATURE UNIT viewed from BUTTON or WIPER side 12 step unit. Wipers shown in zero or reset position

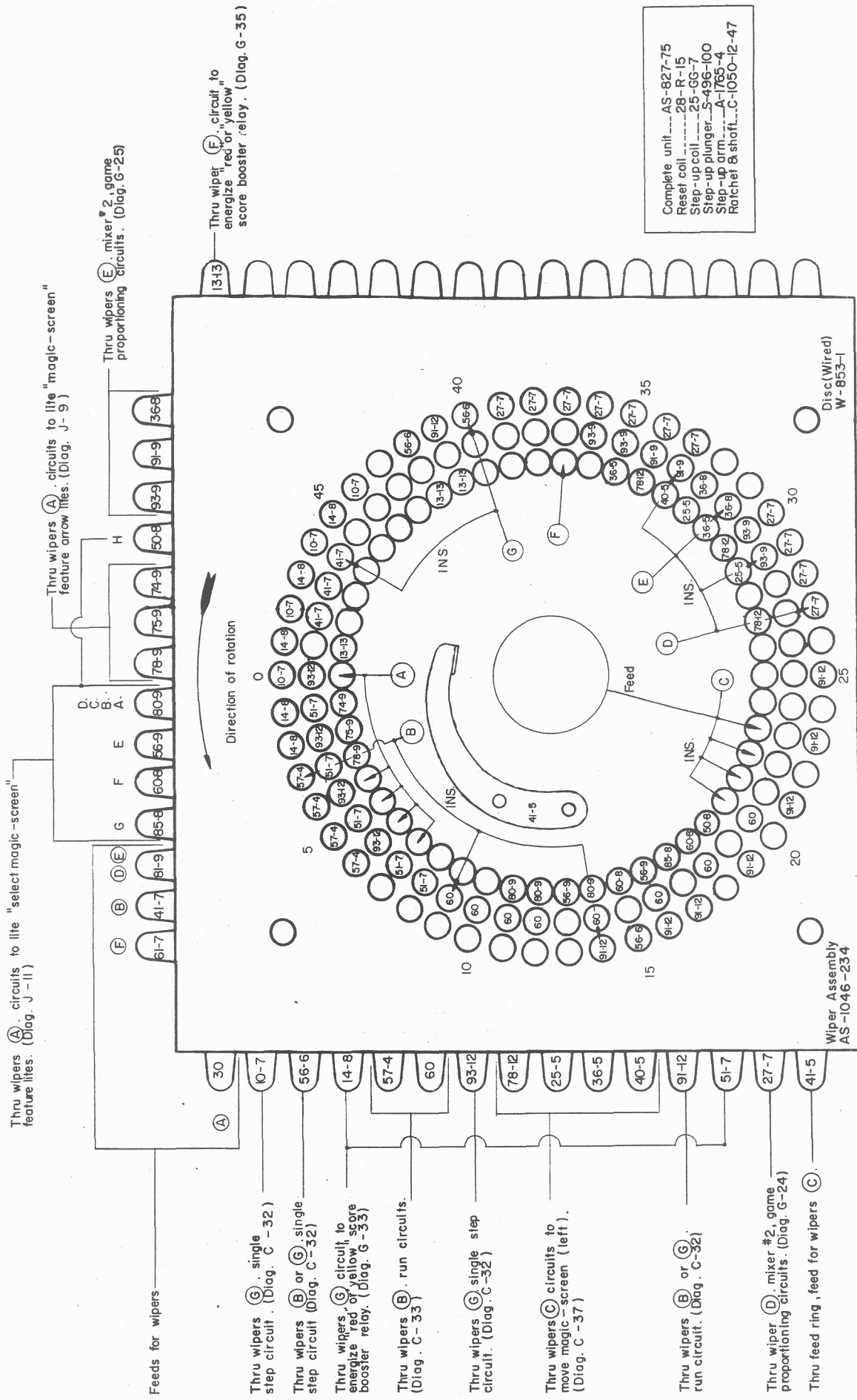

Feeds for wipers

Thru wipers (G) single step circuit. (Diag. C-32)

Thru wipers (B) or (G) single step circuit (Diag. C-32)

Thru wipers (G) circuit to energize "red or yellow" score booster relay. (Diag. G-33)

Thru wipers (B) run circuits. (Diag. C-33)

Thru wipers (G) single step circuit. (Diag. C-32)

Thru wipers (C) circuits to move magic-screen (left). (Diag. C-37)

Thru wipers (B) or (G) run circuit. (Diag. C-32)

Thru wiper (D) mixer #2, game proportioning circuits. (Diag. G-24)

Thru feed ring, feed for wipers (C)

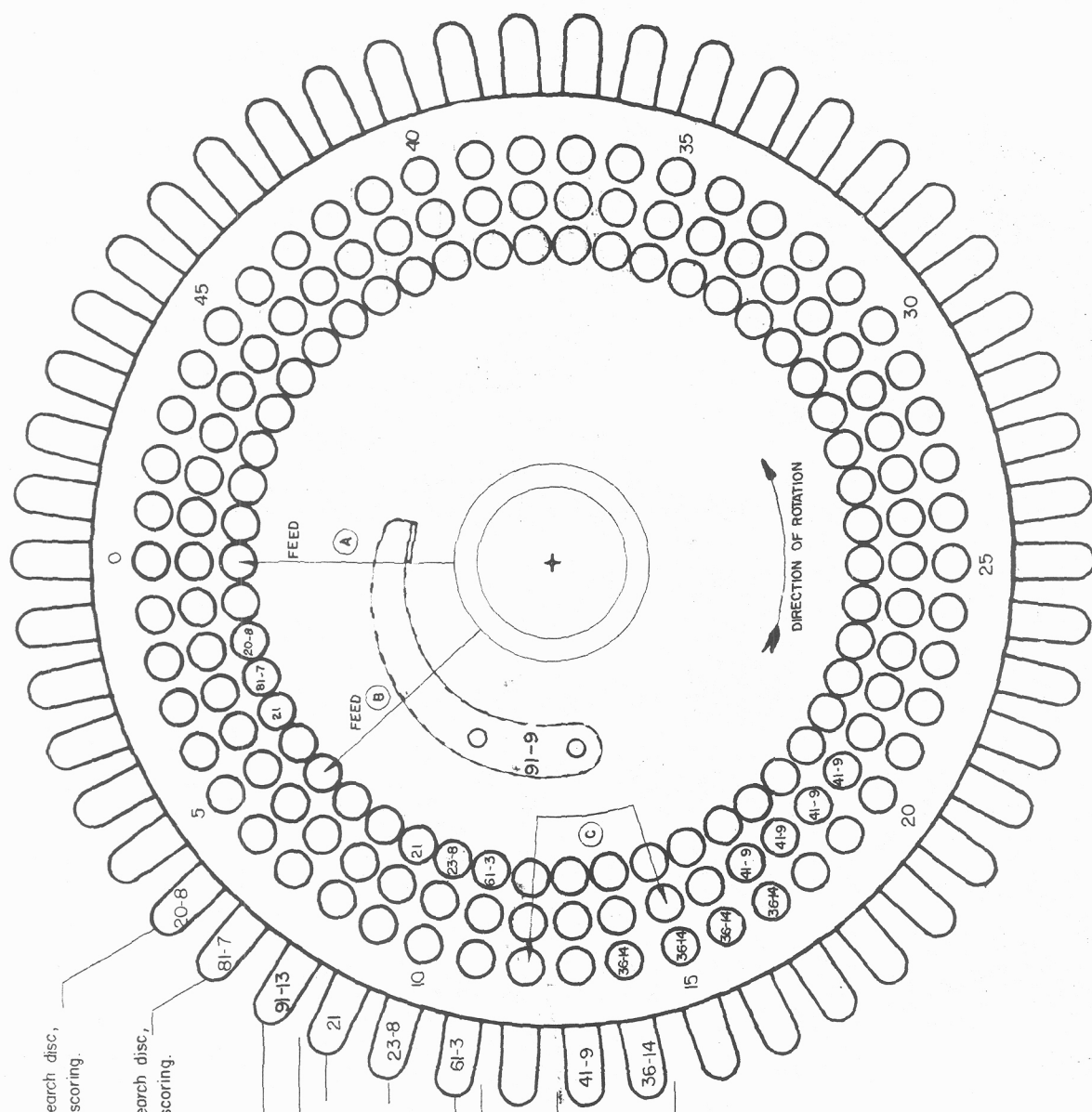

Thru wiper (A) circuit to search disc,
for 2-in-a blue section scoring.
(Diag. H-18)

Thru wiper (A) circuit to search disc,
for 3-in-a blue section scoring.
(Diag. H-18)

Thru feed ring, feed
for wipers (A) & (B)

Thru wiper (B) circuits to
search disc for yellow, red,
and green section scoring.
(Diag. H-18)

Thru wipers (C), lock-in circuit to
search index coil, when any
section winner is being scored.
(Diag. E-17)

- Complete unit ---- AS-827-72
- Reset coil ---- 28-R-15
- Step-up coil ---- 25-GG-7
- Step-up arm ---- A-765-4
- Step-up plunger...S-496-100
- Ratchet & shaft...C-1050-5

Wiper Assembly
AS-1046-223

Disc (Wired)
W-846

REPLAY COUNTER viewed from WIPER side 3 used (see code box at left)

LUG	YELLOW REPLAY COUNTER	RED REPLAY COUNTER	GREEN REPLAY COUNTER
50	57-2	40-3	54-6
75	50-6	52-6	61-6
F	23	71	91
36	51-2	23-3	74-3
24	41-2	20-3	65-3
20	40-2	10-3	63-3
16	23-2	85-2	60-3
8	93-1	83-2	48-3
6	81-1	74-2	43-3
4	78-1	60-2	41-3
40	52-2	25-3	80-3

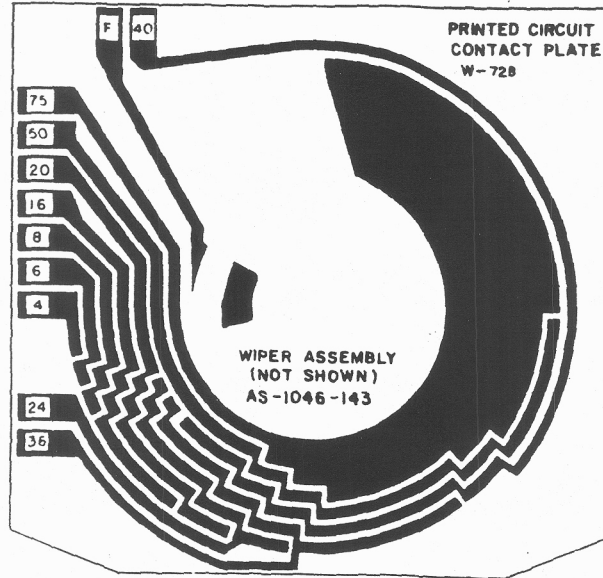

- Complete Unit - AS-797-36
 Reset Coil - 28-R-15
 Step-up Coil - 25-GG-7
 Step-up Plunger - S-496-116
 Step-up Arm - A-1765-49
 Ratchet & Shaft - C-100

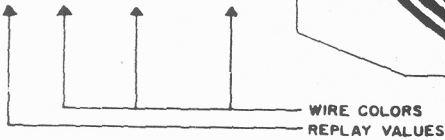

CAM SWITCHES THAT PULSE YELLOW, GREEN & RED REPLAY COUNTER STEP-UP COILS

	sw 13A	sw 13A	sw.13A	sw.13A	sw.12A	sw12 A	sw.11 A	sw.10A
5 IN LINE	75	75	96	96	200	300	450	600
	75	75	NOTE	NOTE	50	75	75	50
4 IN LINE	16	20	24	50	96	144	240	480
	16	20	24	50	24	36	40	40
3 IN LINE	4	6	8	16	32	64	120	192
	4	6	8	16	8	16	20	16

LARGE NUMBERS ARE REPLAY SCORES SHOWN ON BACK GLASS.
 NUMBERS IN SHADED CIRCLES INDICATE WHICH PORTION OF
 REPLAY CIRCUIT STRIP
 IS EFFECTIVE FOR A PARTICULAR REPLAY SCORE.

EXAMPLE: ON A 3-IN-LINE SCORE OF **64** REPLAYS
 THE CIRCUIT IS EFFECTIVE THRU THE **16** REPLAY CIRCUIT STRIP

NOTE: 96 VALUE REPLAY SCORES ARE EFFECTIVE THRU THE OPEN AT 96 SWITCH.

36 SPOTTING DISC viewed from **BUTTON** or **WIPER** side

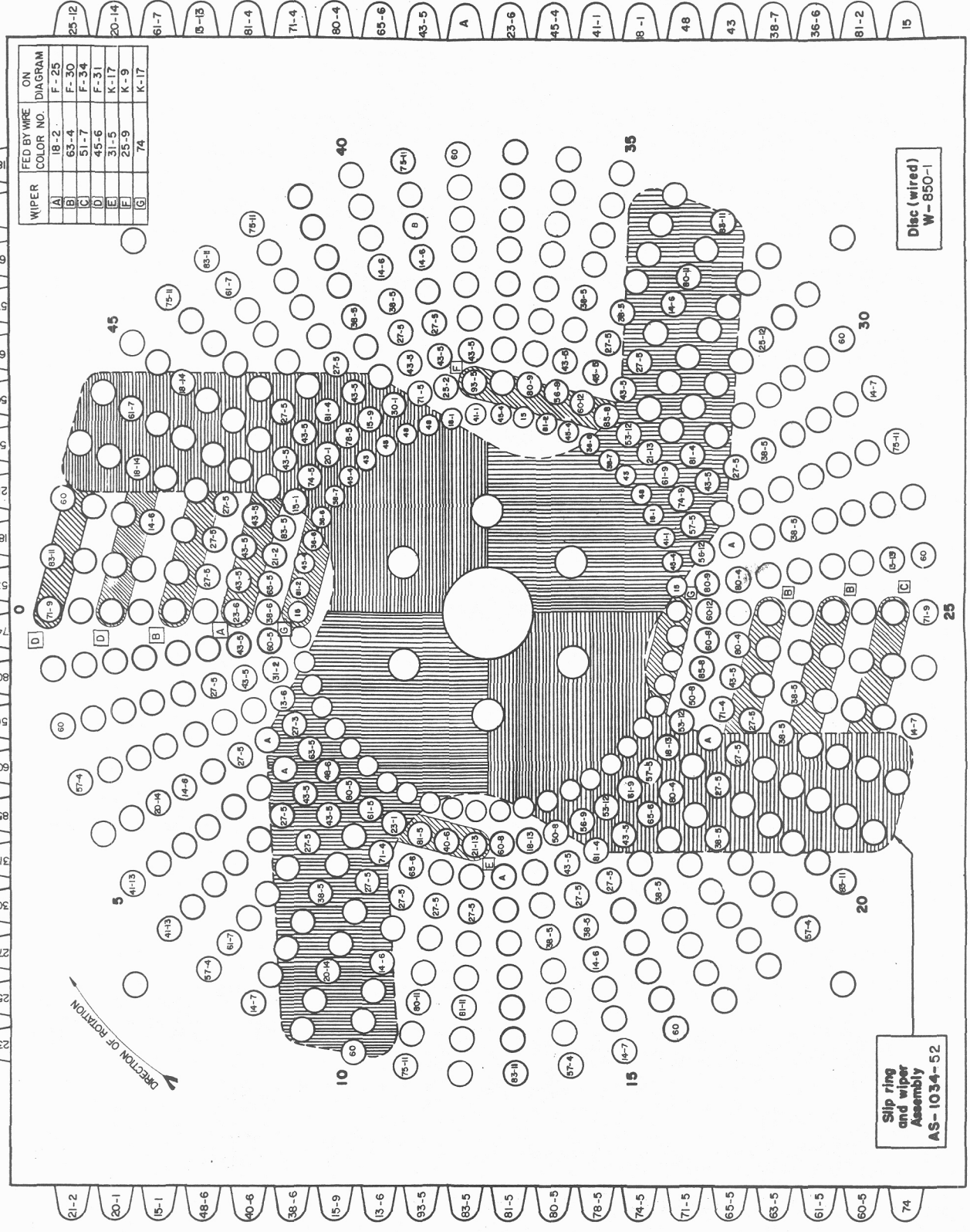

Slip ring and wiper Assembly
AS-1034-52

Disc (wired)
W-850-1

DIRECTION OF ROTATION

SEARCH DISC viewed from BUTTON or WIPER side

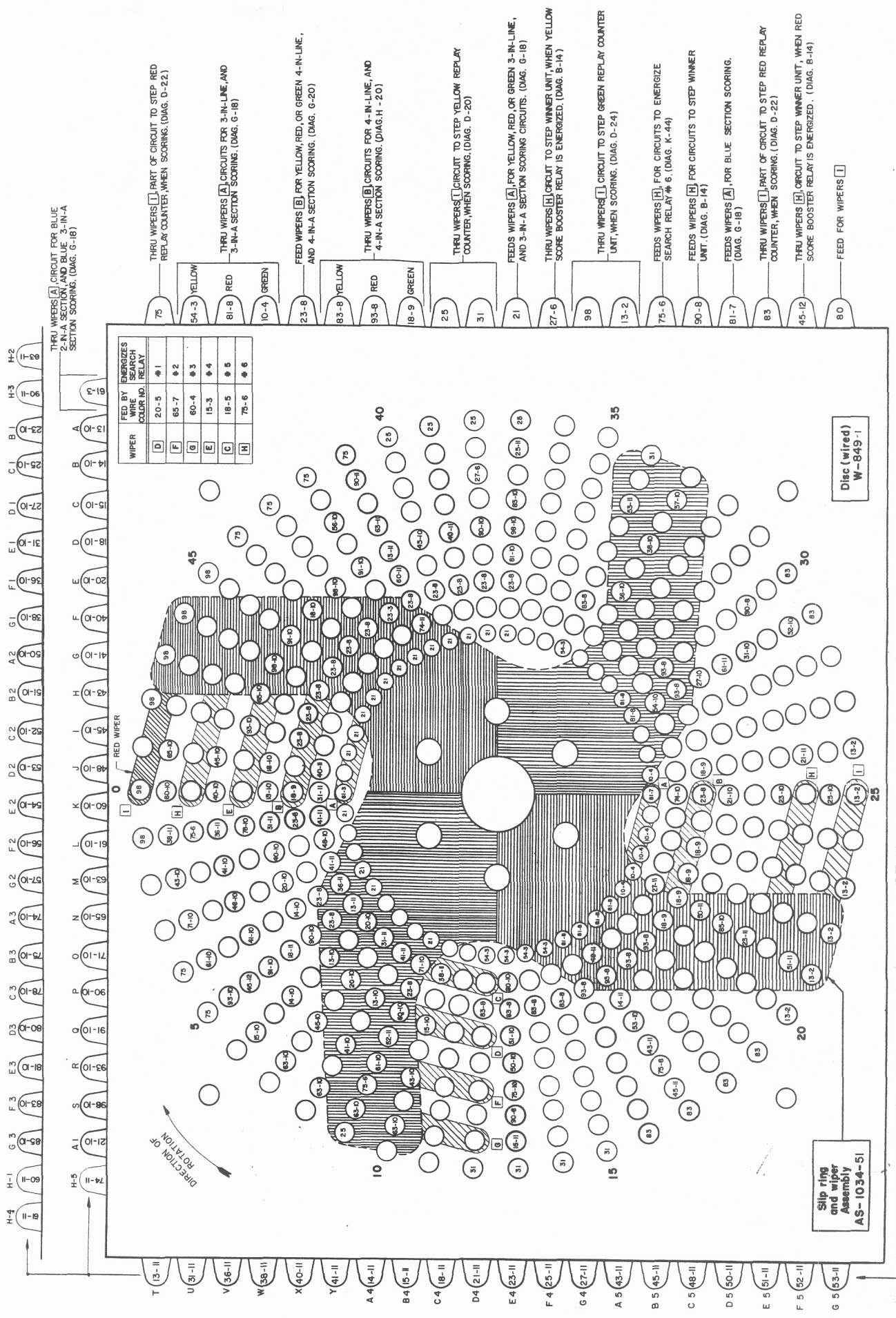

MAGIC SCREEN UNIT viewed from BUTTON or WIPER side

8 step unit. Wipers shown in zero or reset position

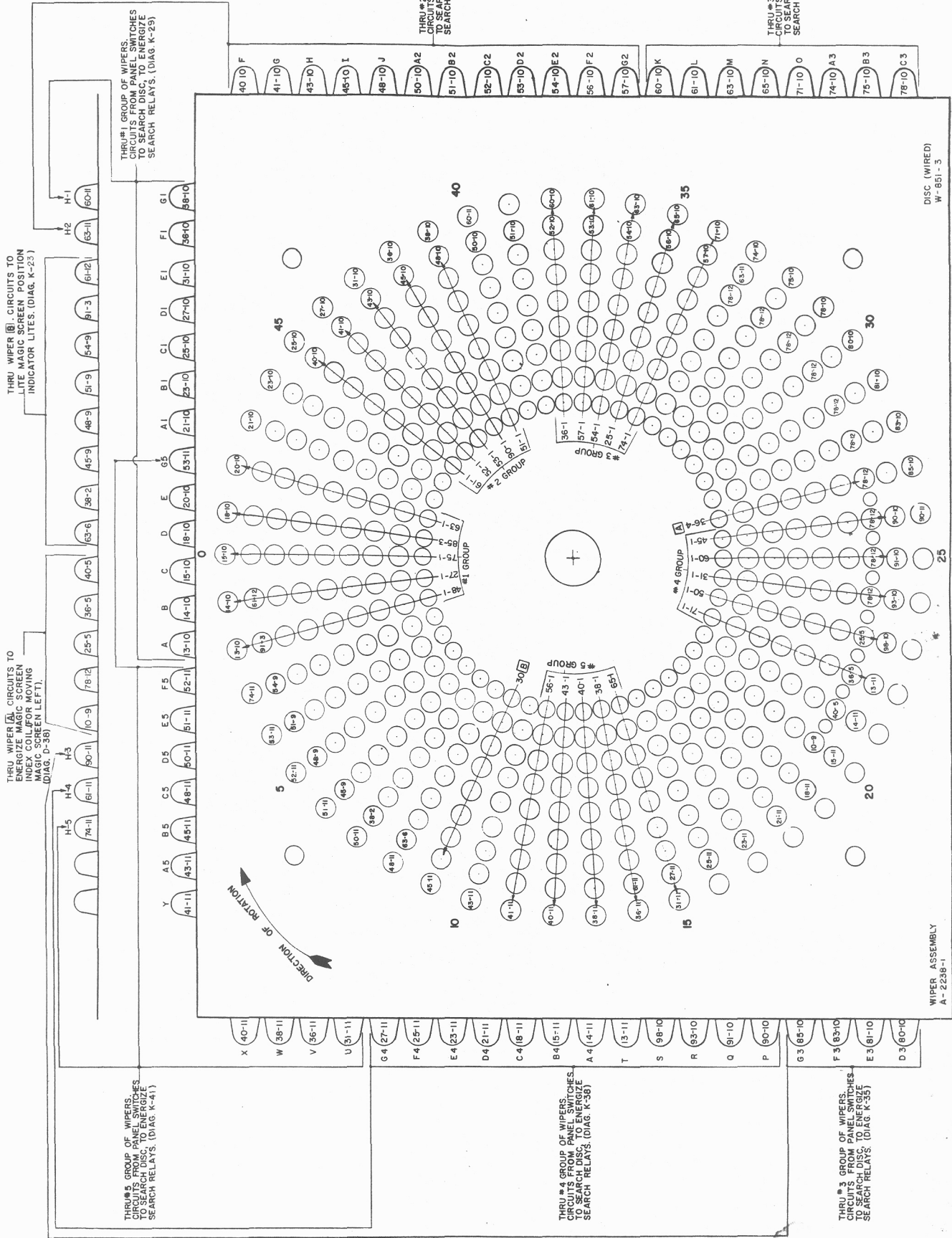

SELECTION FEATURE DISC

viewed from **BUTTON** or **WIPER** side

8 step unit. Wipers shown in zero or reset position

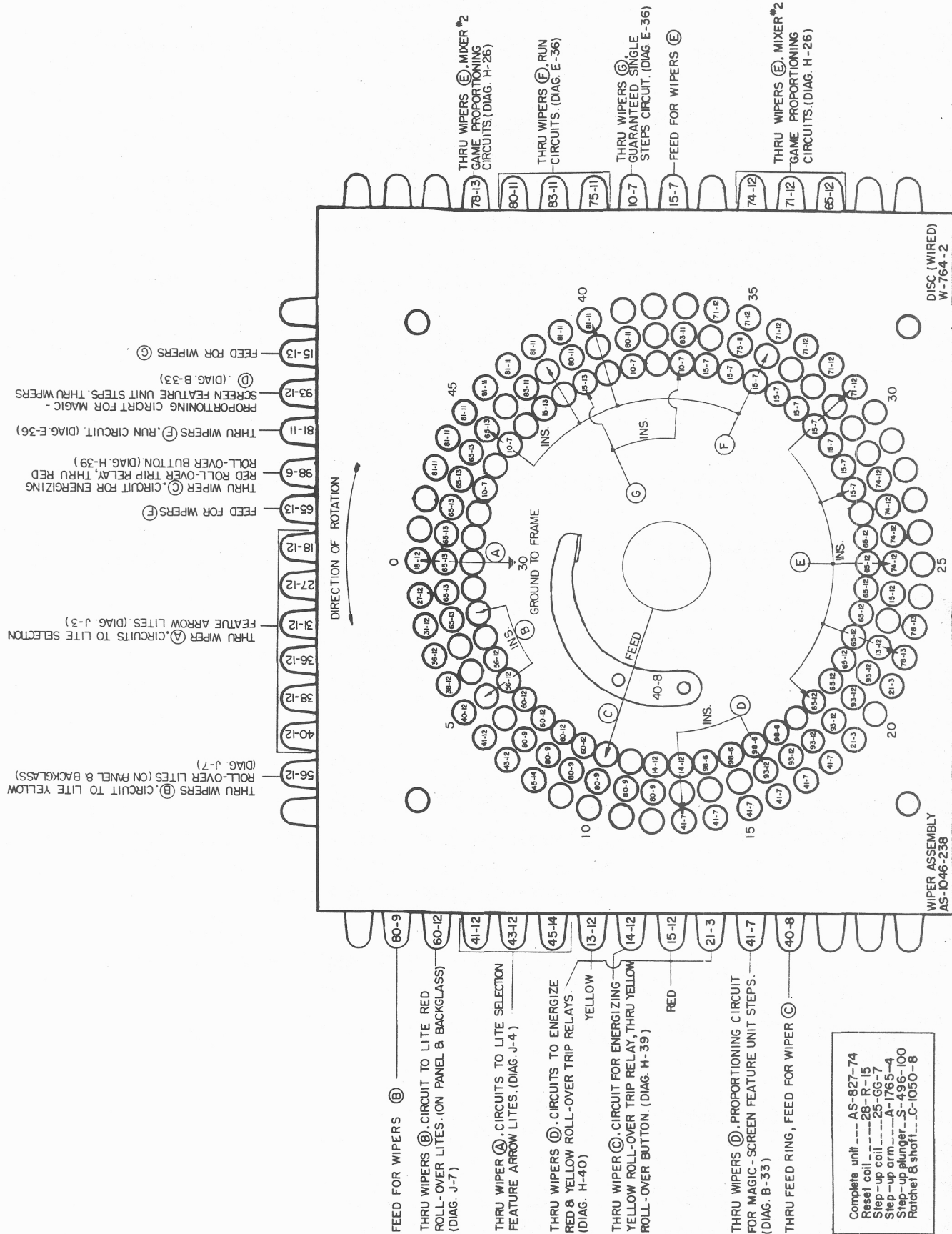

THRU WIPERS (B) CIRCUIT TO LITE YELLOW ROLL-OVER LITES (ON PANEL & BACKGLASS) (DIAG. J-7)

THRU WIPER (A) CIRCUITS TO LITE SELECTION FEATURE ARROW LITES (DIAG. J-3)

FEED FOR WIPERS (F)
 THRU WIPER (C) CIRCUIT FOR ENERGIZING RED ROLL-OVER TRIP RELAY, THRU RED ROLL-OVER BUTTON (DIAG. H-39)
 THRU WIPERS (F) RUN CIRCUIT (DIAG. E-36)
 SCREEN FEATURE UNIT STEPS, THRU WIPERS (D) (DIAG. B-33)
 FEED FOR WIPERS (G)

80-9
 60-12
 41-12
 43-12
 45-14
 13-12
 14-12
 15-12
 21-3
 41-7
 40-8

FEED FOR WIPERS (B)
 THRU WIPERS (B) CIRCUIT TO LITE RED ROLL-OVER LITES (ON PANEL & BACKGLASS) (DIAG. J-7)
 THRU WIPER (A) CIRCUITS TO LITE SELECTION FEATURE ARROW LITES (DIAG. J-4)
 THRU WIPERS (D) CIRCUITS TO ENERGIZE RED & YELLOW ROLL-OVER TRIP RELAYS (DIAG. H-40)
 THRU WIPER (C) CIRCUIT FOR ENERGIZING YELLOW ROLL-OVER TRIP RELAY, THRU YELLOW ROLL-OVER BUTTON (DIAG. H-39)
 RED
 THRU WIPERS (D) PROPORTIONING CIRCUIT FOR MAGIC-SCREEN FEATURE UNIT STEPS (DIAG. B-33)
 THRU FEED RING, FEED FOR WIPER (C)

- Complete unit --- AS-827-74
- Reset coil --- 28-R-15
- Step-up coil --- 23-GG-7
- Step-up arm --- A-1765-4
- Step-up plunger --- S-496-100
- Ratchet & shaft --- C-1050-8

WIPER ASSEMBLY
 AS-1046-238

DISC (WIRED)
 W-764-2

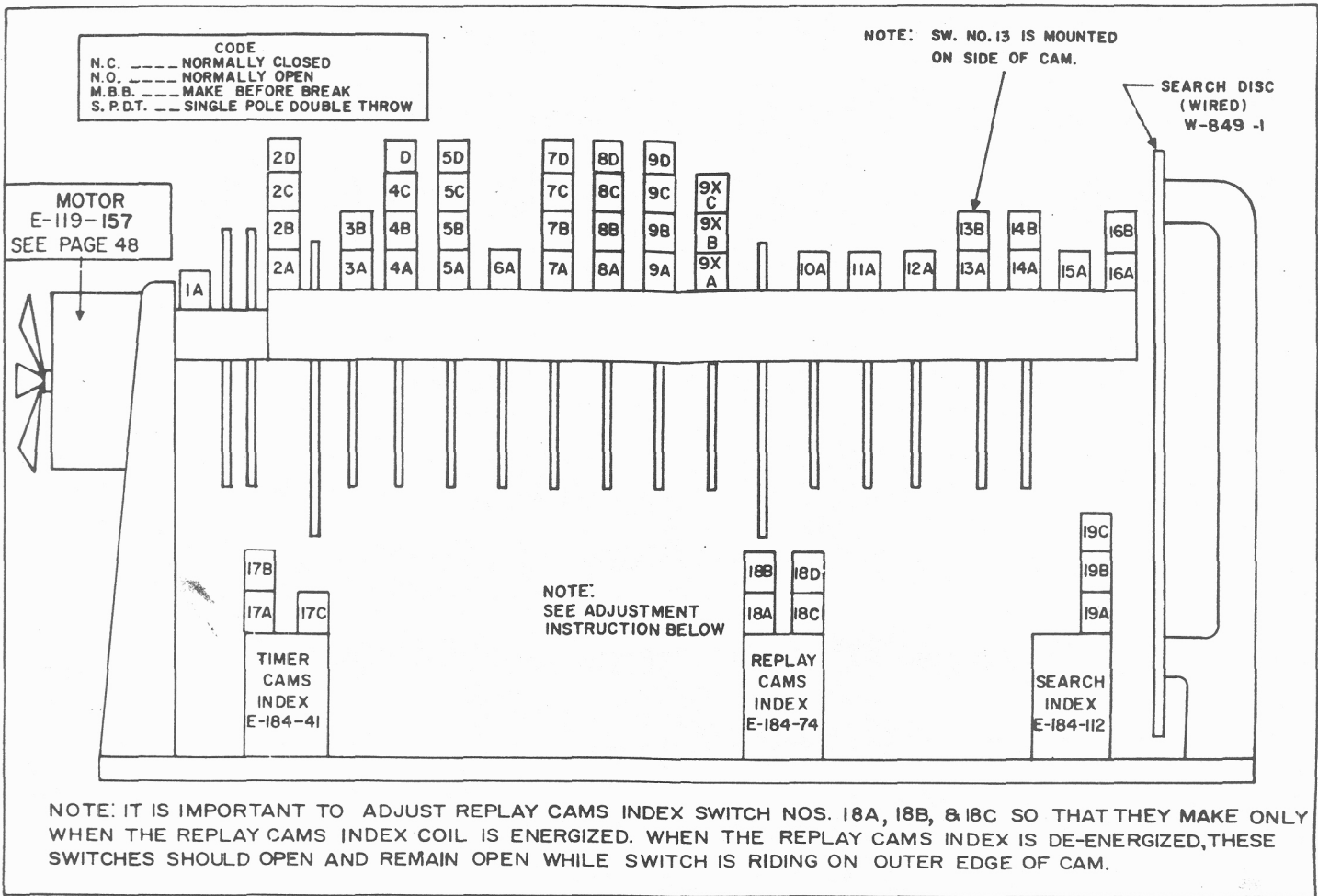

CORRECT ADJUSTMENT: CONTROL UNIT CAM SWITCHES 13, 13A & 13B

NOTICE: IMPORTANT PART OF ILLUSTRATION IS TO SHOW THAT SWITCH 13 CLOSSES FIRST AND OPENS LAST. IF AN ADJUSTMENT IS NECESSARY, SWITCH 13 CAN BE MOVED UP OR DOWN. LOOSEN SCREWS THAT HOLD SWITCH, THEN MOVE UP OR DOWN.

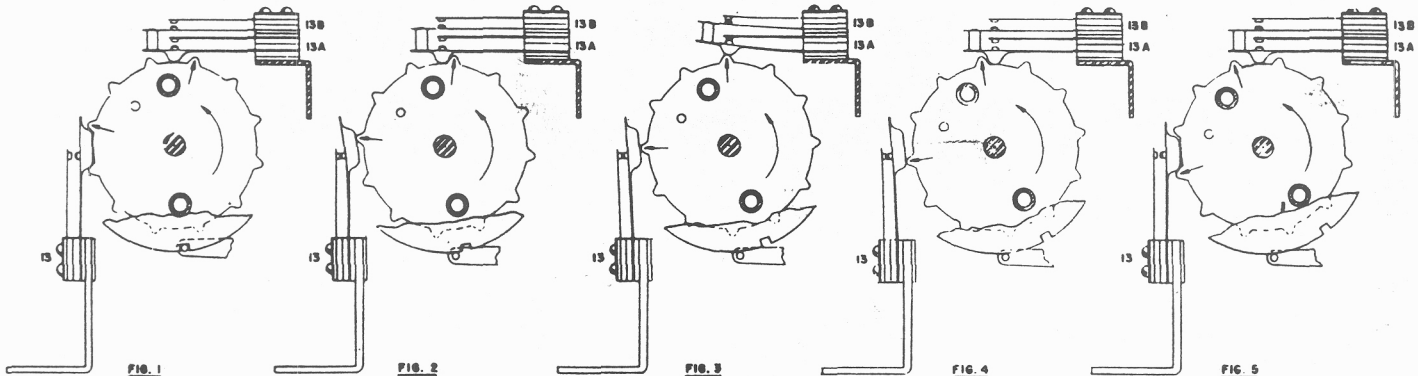

REPLAY CAMS SHOWN IN THEIR NORMAL INDEXED POSITION. SWITCHES 13A, 13B, & 13 ARE OPEN AT THIS TIME.
 NOTE: ARROWS POINT TO LOBES THAT WILL ACTUATE SWITCHES.

REPLAY CAMS SHOWN STARTING TO ROTATE. THEY ARE NOW OUT OF THEIR INDEX POSITION. SWITCHES 13A, & 13B ARE STILL OPEN. SWITCH 13 IS NOW CLOSED.

SWITCHES 13A, & 13B ARE NOW CLOSED. SWITCH 13 IS STILL CLOSED.

SWITCHES 13A, & 13B ARE NOW OPEN AGAIN. SWITCH 13 IS STILL CLOSED.

ALL SWITCHES ARE NOW OPEN AGAIN, SAME AS IN FIG. 1. THIS SEQUENCE IS REPEATED THRUOUT REPLAY SCORING CYCLE.

CONTROL UNIT CAM SWITCH CHART FOR POSITION OF SWITCHES REFER TO PICTORIAL VIEW ON PAGE 40

CAM SWITCH	LOCATION ON DIAGRAM	WIRE No.	WIRE COLORS	FUNCTION OF SWITCHES
1A	N.O.	36-9 65-2	Yellow-Brown Brown-White	Completes circuit to step timer unit, after shooting 5th ball.
2A	N.O.	90-5 30	Gray Yellow	Completes circuit to energize reflex play magnet, and replay register reset coil. Also pulses total plays meter.
2B	N.O.	93-4 30	Gray-Yellow Yellow	Completes circuit to energize coin kicker coil.
2C	N.C.	31-7 57-6	Yellow-Red White-Orange	Breaks lock-in circuit for red button relay.
2D	N.O.	10-2 61-7	Red Brown-Red	Completes circuit to energize "red" or "yellow" score booster relay.
3A	N.C.	48-2 63-3	Green-Black Black-Yellow	Breaks lock-in circuit for start relay, and acts as safety switch during cycle.
3B	S.P.D.T.	93-7 98-4 91-7	Gray-Yellow Gray-Black Gray-Red	Directs circuit from replay meter, to total plays meter.
4A	N.O.	98-1 30	Gray-Black Yellow	Completes circuit to energize spotting cams index coil.
4B	N.O.	56-5 30	White-Brown Yellow	Completes circuit to energize score extra step index coil.
4C	N.O.	27-9 80-2	Blue-Orange Black	Completes circuit to pulse coin meter.
4D	S.P.D.T.	13-9 90-8 14-5	Red-Yellow Gray Red-Green	(Safety circuit) breaks circuit to start relay, and completes circuit to energize tilt relay if coin switch is closed too long.
5A	N.O.	66-2 89-1	Brown-White Brown-Yellow	Completes circuit to reset timer unit while playing extra-balls.
5B	N.O.	21-1 38-4	Blue-Red Yellow-Black	Completes circuit to energize extra-ball unit step-up coil, for single steps.
5C	N.O.	78-4 91-6	Orange-Black Gray-Red	Completes circuit to energize anti-cheat relay.
5D	N.O.	10-7 85-4	Red Black-White	Completes circuit to energize "magic-screen" and "selection feature" unit step-up coils, for single steps.
6A	N.C.	51-5 73-5	White-Red Orange-White	Opens game advantage circuits, during cycle.
7A	N.O.	10-1 75-8	Red Orange-White	Completes circuit to energize yellow score unit step-up coil, for single steps.
7B	N.O.	90-6 63-4	Brown Brown-Yellow	Completes circuit to yellow, red, and green score unit step-up coils, for single steps.
7C	N.O.	23-9 83-4	Blue-Yellow Black-Yellow	Completes circuit to energize red score unit step-up coil, for single steps.
7D	N.O.	90-4 91-5	Gray Gray-Red	Completes circuit to energize green score unit step-up coil, for single steps.

CAM SWITCH	LOCATION ON DIAGRAM	WIRE No.	WIRE COLORS	FUNCTION OF SWITCHES
8A	N.O.	14-8 56-6	Red-Green White-Brown	Completes circuit to energize "magic-screen" feature unit step-up coil, for single steps.
8B	N.O.	25-4 38-4	Blue-White Yellow-Black	Completes circuit to energize extra-ball unit step-up coil, for single steps.
8C	N.O.	18-7 61-7	Red-Black Brown-Red	Completes circuit to energize yellow score booster relay.
8D	N.O.	93-4 30	Gray-Yellow Yellow	(Safety circuit) to energize coin kicker coil.
9A	ALT.	43-5 74-7	Green-Yellow Orange-Green	(Proportioning circuit) for extra-ball unit steps.
9B	ALT.	85-12 10-2 20-7	Black-White Red Blue	(Proportioning circuit) for red or yellow score booster relays.
9C	ALT.	15-7 54-6	Red-White White-Green	(Proportioning circuit) for extra-ball unit steps.
9D	ALT.	41-7 93-12	Gray-Red Gray-Yellow	(Proportioning circuit) for "magic-screen" feature unit steps.
9XA	ALT.	14-13 25-12	Red-Green Blue-White	(Proportioning circuit) for blue score-booster relay.
9XB	ALT.	15-13 65-13	Red-White Brown-White	(Proportioning circuit) for "selection-feature" unit steps.
9XC	ALT.	27-7 81-9	Blue-Orange Black-Red	(Proportioning circuit) for all "game features."
MULT. X12 10A	N.O.	63 70	Brown-Yellow Orange	Completes circuit to step replay counters for scoring, when score units are at 8th step.
MULT. X6 11A	N.O.	57 70	White-Orange Orange	Completes circuit to step replay counters for scoring, when score units are at 7th step.
MULT. X4 12A	N.O.	52 70	White-Blue Orange	Completes circuit to step replay counters for scoring, when score units are at 5th or 6th step.
MULT. X1 13A	N.O.	45 70	Green-White Orange	Completes circuit to step replay counters for scoring, when score units are at 1st, 2nd, 3rd or 4th step.
13B	N.O.	48-4 80	Green-Black Black	Completes circuit to pulse replay register step-up coil, reflex replay magnet, and replay meter, when scoring.
13	N.O. BACKSIDE	21-3 27	Blue-Red Blue-Orange	Completes replay scoring lock-in circuit. (Note: See control unit pictorial view for adjustment)
14A	N.C.	14 18	Red-Green Red-Black	In series circuit for in-line or section replay scoring.
14B	N.C.	27-2 90-2	Blue-Orange Gray	Breaks timer unit step-up circuit, during replay scoring.
15A	N.O.	21-3 31-6	Blue-Red Yellow-Red	Completes circuit to reset sequence unit, and winner unit.
CHANGE-OVER 16A	S.P.D.T.	56 18 54	White-Brown Red-Black White-Green	Directs in-line or section replay scoring circuit.
CHANGE-OVER 16B	S.P.D.T.	80 51-8 41-9	Black White-Red Green-Red	Directs circuit to energize search index coil for in-line or section replay scoring.

CONCLUDED ON NEXT PAGE

CONTROL UNIT CAM SWITCH CHART
 FOR POSITION OF SWITCHES REFER TO PICTORIAL VIEW ON PAGE 40

CAM SWITCH	LOCATION ON ON DIAGRAM	WIRE No.	WIRE COLORS	FUNCTION OF SWITCHES
TIMER CAMS INDEX COIL	A-6	93-2 70	Gray-Yellow Orange	Energized when playing coins or replays.
17A N.O.	G-1	20P 60P	Blue (Plastic) Brown (Plastic)	Completes circuit to run control unit, and mixer and spotting unit motors
17B N.C.	G-5	27-9 71-2	Blue-Orange Orange-Red	Breaks circuit to coin lock-out magnet, during cycle.
17C N.C.	E-12	13 30	Red-Yellow Yellow	Breaks circuit to red button relay, and extra-ball relays, during cycle.
REPLAY CAMS INDEX COIL	A-18	40-4 70	Green Orange	Energized by search index switch #10B, and releases replay cams for scoring.
18A N.O.	G-17	27 80	Blue-Orange Black	In series with replay lock-in circuit, during in-line or section scoring. (Note: See control unit pictorial view for correct adjustment)
18B N.O.	H-15	14 18	Red-Green Red-Black	In series with in-line or section replay scoring circuit. (Note: See control unit pictorial view for correct adjustment)
18C N.O.	F-17	36-14 80	Yellow-Brown Black	In series with replay lock-in circuit, during section scoring. (Note: See control unit pictorial view for correct adjustment)
18D N.C.	B-17	15-2 91-8	Red-White Gray-Red	Breaks direct 80 volt circuit to search index coil, coil then held in thru resistor.
SEARCH INDEX COIL	A-17	15-2 70	Red-White Orange	Energized thru control unit change-over cam switch #16B, for in-line or section replay scoring.
19A N.O.	H-17	54 91-9	White-Green Gray-Red	Completes circuit for section replay scoring.
19B N.O.	B-18	40-4 80	Green Black	Completes circuit to energize replay cams index coil.
19C N.C.	I-4	15-5 83-3	Red-White Black-yellow	Breaks start circuit, and acts as safety switch.
20A N.C.	F-38	14-4 20-2	Red-Green Blue	(Not shown on pictorial view) breaks circuit for moving "magic-screen" left or right.

MIXER AND SPOTTING UNIT ASSEMBLY
 NUMBERS CORRESPOND TO SWITCH CHART BELOW

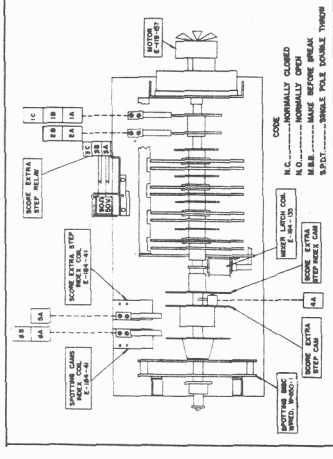

MIXER AND SPOTTING UNIT CAM SWITCH CHART
 FOR POSITION OF SWITCHES REFER TO PICTORIAL VIEW ABOVE

CAM SWITCH	LOCATION ON ON DIAGRAM	WIRE No.	WIRE COLORS	FUNCTION OF SWITCHES
16 Pulse 1A N.O.	F-31	14-8 45-6	Red-Green Green-White	Pulses magic-screen feature unit and selection feature unit for multiple steps. Also energizes blue score booster relay.
16 Pulse 1B N.O.	D-3	53-7 70-2	White-Yellow Orange-White	Pulses replay register unit reset coil.
16 Pulse 1C N.O.	J-1	80-9 90	Black Gray	Flashes "select-now" lite, thru timer unit disc.
16 Pulse 2A N.O.	F-14	52-8 83	White-Blue Gray-Yellow	Pulses sequence unit and wimer unit step-up coil, when searching for section winner.
16 Pulse 2B N.O.	B-25	38-4 78	Yellow-Black Orange-Black	Pulses extra-ball unit step-up coil, for multiple steps.
SCORE EXTRA STEP RELAY COIL	A-9	43-6 70	Green-Yellow Orange	Energized by red, yellow, and green score unit step-up arm switches.
3A N.O.	C-9	43-6 81-3	Green-Yellow Black-Red	Lock-in circuit for this relay.
3B N.O.	C-28	50-4 51-6	White White-Red	Completes circuit for yellow, red or green score unit multiple steps.
3C N.C.	I-4	15-5 30	Red-White Yellow	(Safety switch) opens start circuit, during score unit multiple steps.
4A N.O.	D-28	43-4 50-4	Green-Yellow White	Pulses red, yellow, and green score units for multiple steps.
SCORE EXTRA STEP INDEX COIL	A-41	56-5 70	White-Brown Orange	Energized by control unit cam switch #4B.
5A N.O.	C-10	13-5 81-3	Red-Yellow Black-Red	In series with lock-in circuit for score extra step relay.
SPOTTING CAMS INDEX COIL	A-45	98-1 70	Gray-Black Orange	Energized by control unit cam switch #4A.
6A N.O.	J-20	13-4 30	Red-Yellow Yellow	Flashes game advantage lites. Also flashes extra-ball lites, during extra-ball play.
6B N.O.	J-13	81-6 30	Black-Red Yellow	Flashes game advantage lites.

TRIP RELAY BANK PICTORIAL VIEW NUMBERS CORRESPOND TO SWITCH CHART BELOW

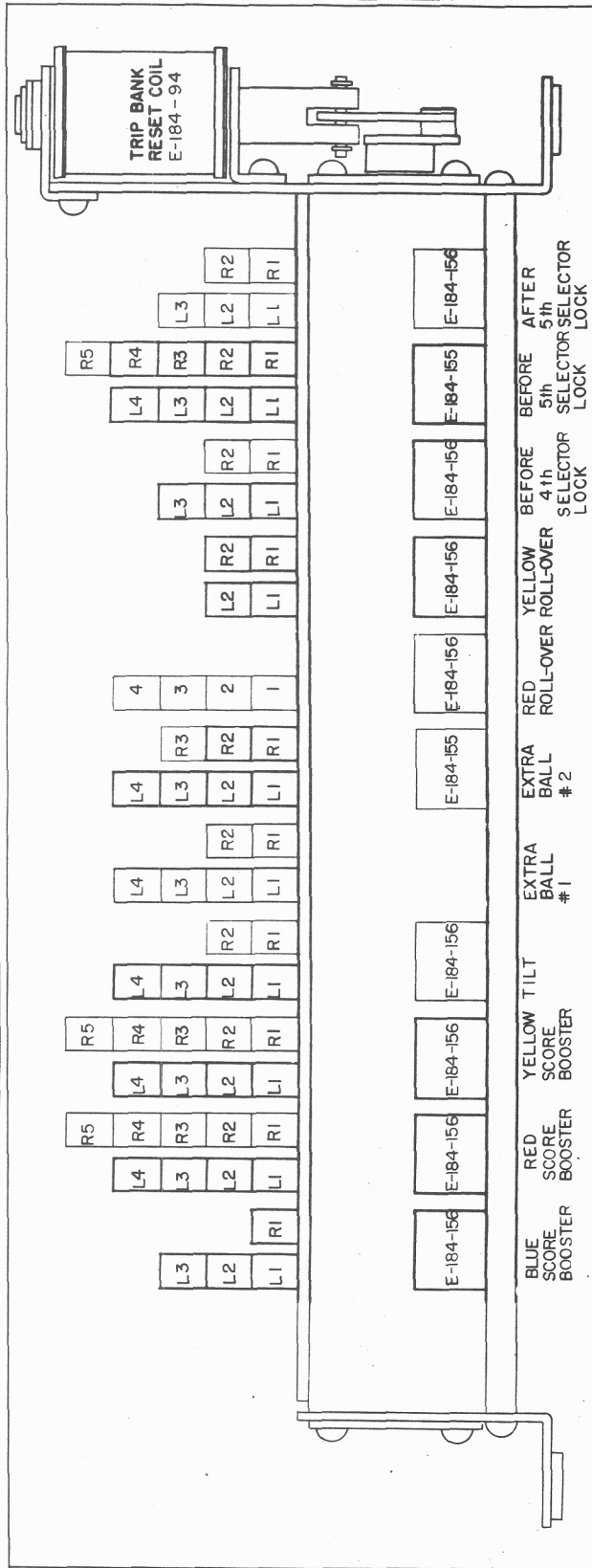

TRIP RELAY BANK CHART FOR POSITION OF SWITCHES REFER TO PICTORIAL VIEW ABOVE

RELAY SWITCH	LOCATION ON DIAGRAM	WIRE No.	WIRE COLORS	FUNCTION OF SWITCHES
BLUE SCORE BOOSTER TRIP COIL	A-36	J, 70	Jumper Orange	Energized thru spotting disc, when circuit complete thru other factors.
L1 S.P.D.T.	L-13	18-4 60-8 61-9	Red-Black Brown Brown-Red	Breaks circuit to "blue 3 scores green 5" feature lite, and completes circuit to "blue 2 scores green 5" feature lite.
L2	B-36	14-13 J	Red-Green Jumper	Breaks circuit to coil.
L3	H-48	20-8 81-7	Blue Black-Red	Completes replay scoring circuit for 2 in a blue section scores green 5-in-line.
R1	N.O.	85-1 30	Black-White Yellow	Completes circuit to blue 2 scores green 5 indicator lite. (To show feature is in play)

RELAY SWITCH	LOCATION ON DIAGRAM	WIRE No.	WIRE COLORS	FUNCTION OF SWITCHES
RED SCORE BOOSTER TRIP COIL	B-35	10-5 85-12	Red Black-White	Energized thru spotting disc, when circuit complete thru other factors.
L1	N.O.	54-7 80-9	White-Green Black	Completes circuit to "red score booster" feature lite.
L2	N.C.	41-13 93-13	Green-Red Gray-Yellow	(Proportioning circuit) for "magic-screen" feature unit steps.
L3	S.P.D.T.	65-4 63-7 52-4	Brown-White Brown-Yellow White-Blue	(Proportioning circuit) for red or yellow score steps.
L4	S.P.D.T.	83-4 25-14 75-8	Black-Yellow Black-White Orange-White	Same as above.
R1	N.O.	13-1 45-12	Red-Yellow Green-White	Thru search disc, completes a circuit to step winner unit.
R2	N.C.	H-24 78-11	Blue-Orange Orange-Black	(Proportioning circuit) for all game advantages.
R3	N.C.	A-34 53-6	Red White-Yellow	Breaks circuit to this coil. Also breaks circuit for energizing "yellow score booster" relay.
R4	N.C.	C-38 38-13	Red-White Yellow-Brown	(Proportioning circuit) for "selection feature" unit steps.
R5	N.C.	L-9 43-7	Blue-Red Green-Yellow	Breaks circuit to flash "yellow score booster" feature lite.

RELAY SWITCH	LOCATION ON DIAGRAM	WIRE No.	WIRE COLORS	FUNCTION OF SWITCHES
YELLOW SCORE BOOSTER TRIP COIL	B-34	10-5 20-7	Red Blue	Energized thru spotting disc, when circuit complete thru other factors.
L1 N.O.	K-8	43-7 80-9	Green-Yellow Black	Completes circuit to "yellow score booster" feature lite.
L2 N.C.	D-32	91-12 93-13	Gray-Red Gray-Yellow	(Proportioning circuit) for "magic-screen" feature unit steps.
L3 S.P.D.T.	D-29	52-4 31-9 65-4	White-Blue Yellow-Red Brown-White	(Proportioning circuit) for red or yellow score steps.
L4 S.P.D.T.	C-29	75-8 38-9 83-4	Orange-White Yellow-Black Black-Yellow	Same as above.
R1 N.O.	B-14	13-1 27-6	Red-Yellow Blue-Orange	Thru search disc, completes a circuit to step winner unit.
R2 N.C.	A-34	53-6 70	White-Yellow Orange	Breaks circuit to this coil. Also breaks circuit for energizing "red score booster" relay.
R3 N.C.	D-36	36-13 65-13	Yellow-Brown Brown-White	(Proportioning circuit) for "selection feature" unit steps.
R4 N.C.	H-24	78-11 81-9	Orange-Black Black-Red	(Proportioning circuit) for all game advantages.
R5 N.C.	L-8	18-13 54-7	Red-Black White-Green	Breaks circuit to flash "red score booster" feature lite.
TILT TRIP COIL	A-12	14-5 70	Red-Green Orange	Energized by any tilt switch. Also thru control unit cam switch #4D, if coin switch is closed too long.
L1 S.P.D.T.	I-7	21-3 30 45-8	Blue-Red Yellow Green-White	Breaks circuit to this coil. Also breaks circuit for game advantages, replay scoring, ball counting, and completes circuit to run shutter motor.
L2 N.C.	H-38	40-8 83-3	Green Gray-Yellow	Breaks circuit to (left and right) magic screen buttons, and collect scores button.
L3 N.C.	M-26	10 20-4	Red Blue	Breaks 17 volt circuit.
L4 S.P.D.T.	M-25	38 54-2 91-2	Yellow-Black White-Green Gray-Red	Breaks 6 volt circuit, and lites tilt lite.
R1 N.O.	F-13	57-6 85-7	White-Orange Black-White	(Safety circuit) for energizing red button relay.
R2 N.C.	G-2	20-P 60-P	Blue (Plastic) Brown (Plastic)	Breaks circuit to control unit, and mixer spotting unit motors.
EXTRA-BALL #1 TRIP	A-13			Trips with extra-ball #2 trip relay.
L1 N.O.	G-9	71-8 83-1	Orange-Red Black-Yellow	Completes circuit to reset timer unit.
L2 N.C.	E-27	85-4 91-6	Black-White Gray-Red	Completes circuit to energize anti-cheat relay, (when this relay is latched).
L3 S.P.D.T.	E-26	85-4 30 61-2	Black-White Yellow Brown-Red	Breaks guaranteed score steps circuit, and completes circuit for extra-ball unit 1st step.
L4 S.P.D.T.	G-28	60-6 27-7 18-2	Brown Blue-Orange Red-Black	Breaks circuit other advantages, and completes circuit for extra-ball steps.
R1 S.P.D.T.	I-28	75-5 15-7 45-2	Orange-White Red-White Green-White	Breaks circuit for other game advantages, and further completes circuit for extra-ball steps.
R2 N.C.	K-13	25-9 81-6	Blue-White Black-Red	Breaks circuit for flashing game advantage lites.

RELAY SWITCH	LOCATION ON DIAGRAM	WIRE No.	WIRE COLORS	FUNCTION OF SWITCHES
EXTRA-BALL #2 TRIP COIL	A-13	J 70	Jumper Orange	Energized by yellow button (on front door) when playing for extra balls.
L1 N.O.	D-13	38-3 91-1	Yellow-Black Gray-Red	Thru extra-ball unit disc, completes circuit to run ball lifter motor.
L2 N.C.	B-13	10-6 J	Red Jumper	Breaks circuit to coil.
L3 S.P.D.T.	D-6	14-3 61 98-2	Red-Green Brown-Red Gray-Black	Breaks circuit to shutter motor, and completes circuit to energize mixer latch, and timer cams index coils.
L4 S.P.D.T.	J-20	31-5 13-4 74	Yellow-Red Red-Yellow Orange-Green	Breaks circuit for flashing score lites, and completes circuit to flash extra-ball lites.
R1 N.O.	J-25	21-4 30	Blue-Red Yellow	Completes circuit to lite extra-balls lite (show extra ball is being played).
R2 N.O.	G-28	27-7 54-8	Blue-Orange White-Green	(Proportioning circuit) for extra ball steps.
R3 N.C.	G-29	45-2 83-9	Green-White Black-Yellow	Breaks circuit for other game advantages.
RED ROLL-OVER TRIP COIL	A-40	J 70	Jumper Orange	Energized direct thru "selection-feature" disc. Also by red roll-over button, thru "selection feature" disc.
1 N.O.	H-38	21-12 93-3	Blue-Red Gray-Yellow	Completes circuit to keep (left and right) magic-screen buttons alive until 6th ball is shot.
2 N.C.	B-40	25-12 J	Blue-White Jumper	Breaks circuit to coil.
3 S.P.D.T.	J-1	51-12 90 52-13	White-Red Gray White-Blue	Breaks circuit to flash "select-now" lite before shooting 4th and before shooting 5th ball, and completes circuit to flash "select-now" lite before shooting 6th ball.
4 S.P.D.T.	J-6	31-8 80-9 53-12	Yellow-Red Black White-Yellow	Breaks circuit to select before 4th and select before 5th ball "feature" lites, and completes circuit to lite select after 5th ball feature lite.
YELLOW-ROLL-OVER TRIP COIL	A-40	J 70	Jumper Orange	Energized direct thru "selection-feature" disc, also by yellow roll-over button, thru selection feature disc.
L1 S.P.D.T.	K-6	57-5 31-8 74-8	White-Orange Yellow-Red Orange-Green	Breaks circuit to lite "select before 4th ball" feature lite, and completes circuit to lite "select before 5th ball" feature lites.
L2 N.C.	B-40	38-13 J	Yellow-Black Jumper	Breaks circuit to coil.
R1 S.P.D.T.	J-1	50-12 51-12 23-5	White White-Red Blue-Yellow	Breaks circuit to flash "select-now" lite before shooting 4th ball, and completes circuit to flash "select-now" lite before 5th ball.
R2 N.O.	H-37	93-3 98-3	Gray-Yellow Gray-Black	Completes circuit to keep (left and right) magic-screen buttons alive until 5th ball is shot.

CONCLUDED ON NEXT PAGE

5 RELAY BANK PICTORIAL VIEW

LETTERS CORRESPOND TO SWITCH CHART BELOW

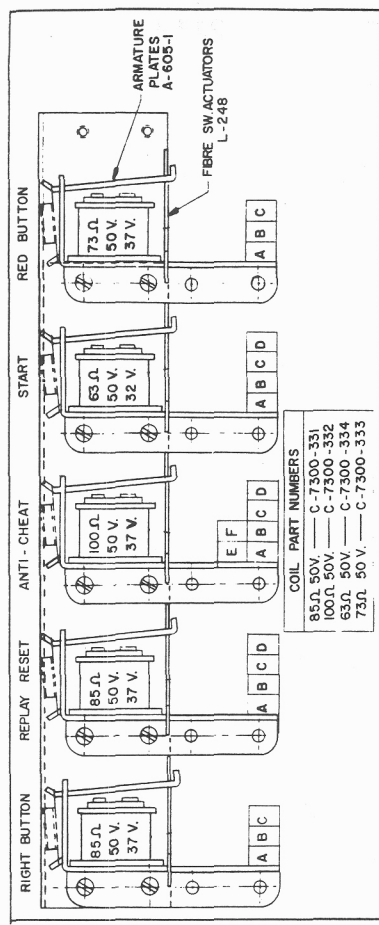

5 RELAY BANK SWITCH CHART

FOR POSITION OF SWITCHES REFER TO PICTORIAL VIEW ABOVE

RELAY SWITCH	LOCATION ON DIAGRAM	WIRE No.	WIRE COLORS	FUNCTION OF SWITCHES
RIGHT BUTTON RELAY COIL	A-39	45-50	Green-White Orange	Energized by right button (on front rail) for moving magic-screen right.
A S.P.D.T.	C-39	48-5 25-6 45-5	Green-Black Blue-White Green-White	Breaks circuit to move left magic screen motor, and completes circuit to move right magic-screen motor. Also completes lock-in circuit for this relay.
B N.O.	B-38	61-4 57-14	Brown-Red White-Orange	Completes circuit to energize magic-screen unit index coil, when moving screen right.
C N.C.	D-38	36-4 36-15	Yellow-Brown Yellow-Brown	Breaks circuit for moving magic-screen left.
REPLAY RESET RELAY COIL	A-4	75-2 70	Orange-White Orange	Energized when anti-cheat relay drops out.
A S.P.D.T.	C-4	90-5 41-6 53-7	Gray Green-Red White-Yellow	Directs replay register reset thru control unit cam switch #2A, when replays are being played, or thru 16 pulse cam #1B, when replays are being cancelled.
B N.O.	G-4	56-2 56-3	White-Brown Orange-White	Completes lock-in circuit for this relay.
C N.O.	G-1	20P 60P	Blue (Plastic) Brown(Plastic)	Completes circuit to run control unit, and mixer-spotting unit motors, when replays are being cancelled.
D N.C.	C-4	21-6 13-9	Blue-Red Red-Yellow	Breaks start circuit, when replays are being cancelled.

CONCLUDED ON NEXT PAGE

TRIP RELAY BANK CHART

FOR POSITION OF SWITCHES REFER TO PICTORIAL VIEW ON PAGE 43

RELAY SWITCH	LOCATION ON DIAGRAM	WIRE No.	WIRE COLORS	FUNCTION OF SWITCHES
BEFORE 4th SELECTOR LOCK TRIP COIL	A-11	J 70	Jumper Orange	Energized thru timer unit disc, when 4th ball is shot.
L1 S.P.D.T.	H-38	98-3 93-3 53	Gray-Black Gray-Yellow White-Yellow	Breaks circuit to magic-screen buttons (left and right) and completes circuit to make collect scores button alive.
L2 N.C.	B-11	83-6 J	Black-Yellow Jumper	Breaks circuit to coil.
L3 N.O.	H-8	36-2 43-2	Yellow-Brown Green-Yellow	Thru timer unit disc, completes a circuit to step timer unit.
R1 N.O.	C-17	23-13 51-8	Blue-Yellow White-Red	Completes circuit to energize search index coil.
R2 N.C.	K-1	27-4 50-12	Blue-Orange White	Breaks circuit for flashing "select-now" lite at 4th step of timer unit.
BEFORE 5th SELECTOR LOCK TRIP COIL	A-11	J 70	Jumper Orange	Energized thru timer unit disc, when 5th ball is shot.
L1 S.P.D.T.	L-1	14-1 48-12 53-2	Red-Green Green-Black White-Yellow	Breaks circuit for flashing "select-now" lite at 5th step of timer unit, and completes circuit to flash "select-now" lite for after 5th selection feature.
L2 N.C.	B-11	74-6 J	Orange-Green Jumper	Breaks circuit to coil.
L3 N.O.	C-13	10-6 25-8	Red Blue-White	Completes circuit to energize extra-ball trip relays, during extra-ball play.
L4 N.O.	E-4	18-6 50-2	Red-Black White	Completes circuit to energize start relay, during extra-ball play.
R1 N.C.	L-7	52-12 56-12	White-Blue White-Brown	Breaks circuit to yellow rollover lite.
R2 N.C.	D-40	13-12 38-13	Red-Yellow Yellow-Black	Breaks circuit for energizing yellow rollover trip relay (thru yellow panel rollover button).
R3 N.O.	G-10	54-11 71-8	White-Green Orange-Red	Completes circuit for resetting timer unit, thru front rail "R" button.
R4 N.O.	F-8	27-2 78-6	Blue-Orange Orange-Black	Completes circuit to step timer unit, after 5th ball is shot.
R5 N.C.	G-38	21-12 98-3	Blue-Red Gray-Black	Breaks circuit to magic-screen buttons (left and right).
AFTER 5th SELECTOR LOCK TRIP COIL	A-11	J 70	Jumper Orange	Energized when 6th ball (1st extra-ball) is shot.
L1 N.C.	G-38	14-4 21-12	Red-Green Blue-Red	Breaks circuit to magic-screen buttons (left and right).
L2 N.C.	C-40	15-12 25-13	Red-White Blue-White	Breaks circuit for energizing red rollover trip relay (thru red panel roll-over button).
L3 N.C.	B-11	98-11 J	Gray-Black Jumper	Breaks circuit to coil.
R1 N.C.	K-2	52-13 53-2	White-Blue White-Yellow	Breaks circuit for flashing "select-now" lite.
R2 N.C.	L-8	41-8 60-12	Green-Red Brown	Breaks circuit to yellow roll-over lite.

5 RELAY BANK SWITCH CHART

FOR POSITION OF SWITCHES REFER TO PICTORIAL VIEW ON PAGE 45

RELAY SWITCH	LOCATION ON ON DIAGRAM	WIRE No.	WIRE COLORS	FUNCTION OF SWITCHES
ANTI-CHEAT RELAY COIL	A-27	79-4 70	Orange-Black Orange	Energized thru control unit cam switch #5C. Switches on this relay protect replay scoring, game advantage, and lite circuits.
A S.P.D.T.	G-4	75-2 66-2 50-2	Orange-White White-Brown White	Breaks start relay circuit, and energizes replay reset relay, when this relay drops out.
B N.O.	D-27	78-4 30	Orange-Black Yellow	Completes lock-in circuit for this relay.
C N.O.	L-23	20-4 80-1	Blue Black	Breaks 17 volt circuit, when this relay drops out.
D N.C.	F-13	57-0 85-7	White-Orange Black-White	(Safety circuit) energizes red button relay, when this relay drops out.
E S.P.D.T.	L-21	91-2 38 40	Gray-Red Yellow-Black Green	Breaks 6 volt circuit to score lites, and lites tilt lite, when this relay drops out.
F N.C.	I-7	14-14 30	Red-Green Yellow	(Safety circuit) closes shutter if this relay drops out, when shutter is open.
START RELAY COIL	A-4	21-0 70	Blue-Red Orange	Energized by coin switch, or by red or yellow button (on front door) when playing replays.
A N.C.	B-25	79-4 78	Orange-White Orange-Black	Opens extra-ball step-up circuit, during spin.
B N.C.	F-30	14-8 59-9	Red-Green Black-Yellow	Opens game advantages circuit, during spin.
C N.O.	F-6	10-10 48-2	Red Green-Black	Completes circuit to energize mixer latch, and timer cams index coils.
D N.O.	F-4	48-2 13-8	Green-Black Red-Yellow	Completes lock-in circuit for this relay.
RED BUTTON RELAY COIL	A-12	85-7 70	Black-White Orange	Energized by red button (on front door).
A S.P.D.T.	C-6	93-2 98-2 14-3	Gray-Yellow Gray-Black Red-Green	Breaks circuit to energize mixer latch, and timer cams index coils during extra-ball play, and completes circuit to open shutter when starting new game - after extra ball play.
B N.O.	D-12	57-8 51-7	Blue-Orange Yellow-Red	Completes lock-in circuit for this relay.
C N.C.	K-22	21-4 50-8	Blue-Red White	Breaks circuit to extra ball feature lite.

SHUTTER MOTOR PICTORIAL VIEW

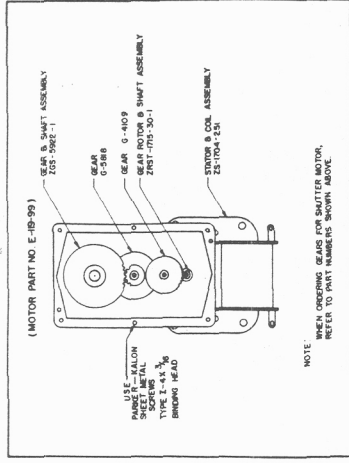
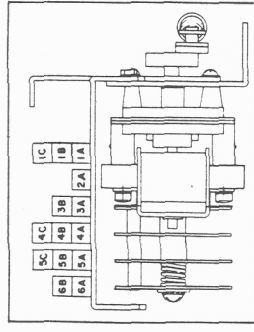

NOTE:
WHICH OPERATING GEARS FOR SHUTTER MOTOR.
REFER TO PART NUMBERS SHOWN ABOVE.

SHUTTER MOTOR CAM SWITCH CHART

FOR POSITION OF SWITCHES SEE PICTORIAL VIEW

RELAY SWITCH	LOCATION ON ON DIAGRAM	WIRE No.	WIRE COLORS	FUNCTION OF SWITCHES
1A	N.C.	14 21-3	Red-Green Blue-Red	(Closed when shutter is closed). Completes circuit for section or in-line replay scoring, thru change-over cam switch.
1B	N.O.	14-3 30	Red-Green Yellow	Completes carry-over circuit to shutter motor.
1C	N.C.	21-3 98-8	Blue-Red Gray-Black	(In series with shutter motor cam switch 5B) (Safety circuit) timer unit reset.
2A	N.C.	31-3 39-3	Yellow-Red Yellow-Brown	(Closed when shutter is closed) completes circuit to lifter motor.
3A	N.O.	85-5 30	Black-White Yellow	Completes circuit to reset extra-ball, yellow, red and green replay counter units, when starting new game.
3B	N.O.	H-2 70P	Blue (Plastic) Orange (Plastic)	Completes circuit to reset trip relay bank, when starting new game.
4A	N.O.	14-3 18-3	Red-Green Red-Black	(In series with shutter motor cam switch #4C) Completes circuit to shutter motor, if game is tilted with shutter open.
4B	N.C.	21-3 40-8	Blue-Red Green	(Closed when shutter is closed) Completes circuit to operate magic-screen (left and right). Also completes circuit to front rail collect scores button switch.
4C	N.O.	18-3 45-8	Red-Black Green-White	(See function of switch 4A above.)
5A	N.O.	31-4 91-4	Yellow-Red Gray-Red	(Closed when shutter is open) (Safety circuit) lifter start relay.
5B	N.C.	H-8 98-8	Brown-White Gray-Black	(See function of switch IC above.)
5C S.P.D.T.	E-6	61 10-10 99-2	Red Red-Yellow Gray-Yellow	Directs circuit to run shutter motor, or energize mixer latch and timer cams index coils.
6A	N.O.	H-8 30	Orange-Red Yellow	Completes circuit to reset timer unit, when starting new game.
6B	N.O.	C-44 30	Orange-Black Yellow	Completes circuit to reset magic screen feature unit, and yellow, red, and green score units, when starting new game.

BALL LIFT MOTOR PICTORIAL VIEW

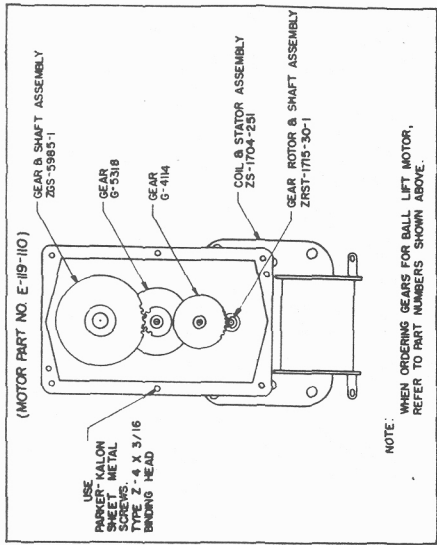
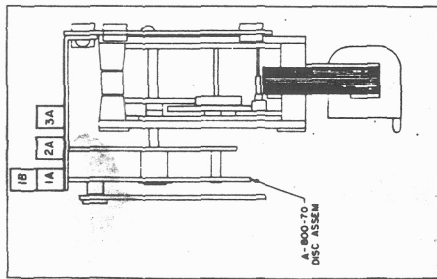

BALL LIFT MOTOR CAM SWITCH CHART FOR POSITION OF SWITCHES SEE PICTORIAL VIEW

RELAY SWITCH	LOCATION ON DIAGRAM	WIRE No.	WIRE COLORS	FUNCTION OF SWITCHES
1A	N.C.	15-6 89-6	Red-White Black-White	(Safety circuit) for before 5th selector lock trip relay.
1B	N.O.	91-1 30	Grey-Red Yellow	Completes carry-over circuit to ball lift motor.
2A	N.O.	27-2 43-2	Blue-Orange Green-Yellow	Completes circuit to energize timer unit step-up coil.
3A	N.O.	21-3 89-7	Blue-Red Black-Yellow	Completes circuit to energize before 4th selector lock relay, thru timer unit disc.

MAGIC SCREEN UNIT MOTOR

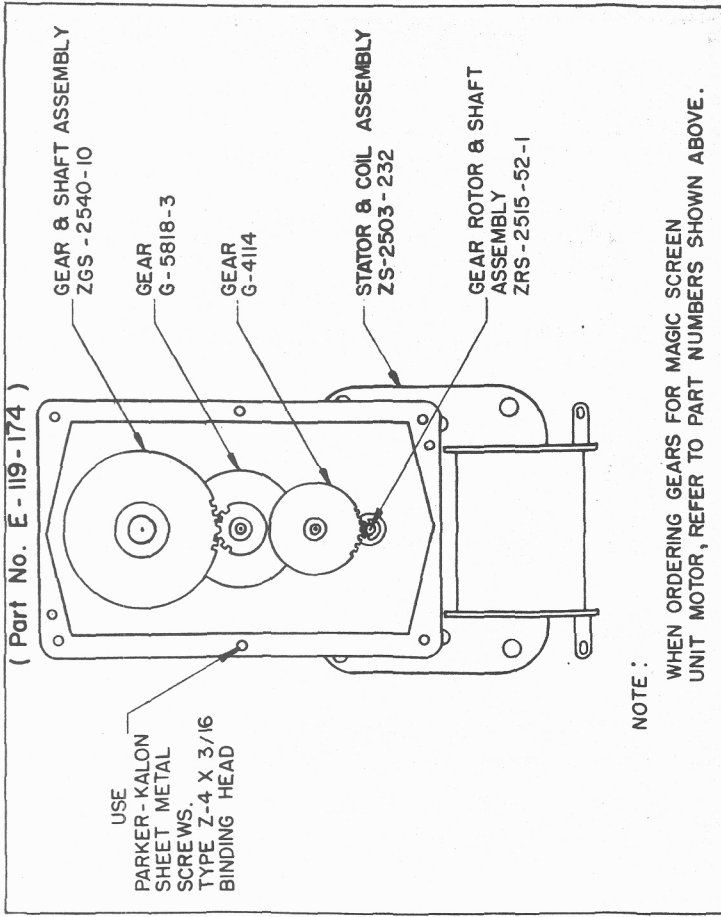

MAGIC SCREEN UNIT PARTS

PART No.	NAME
AS-1809-1	Complete Magic Screen Unit assembly
W-851-3	Contact plate
26-GG-10	Coil
A-613-55	Core plug
AS-1846-1	Index Arm and plunger assembly
P-163-32	Key Washer
M-943	Ladder Chain
P-801-310	Leather Washer
E-119-174	Motor
S-496-152	Plunger only for AS-1846-1

MOTOR ASSEMBLY (Part No. E-119-157)

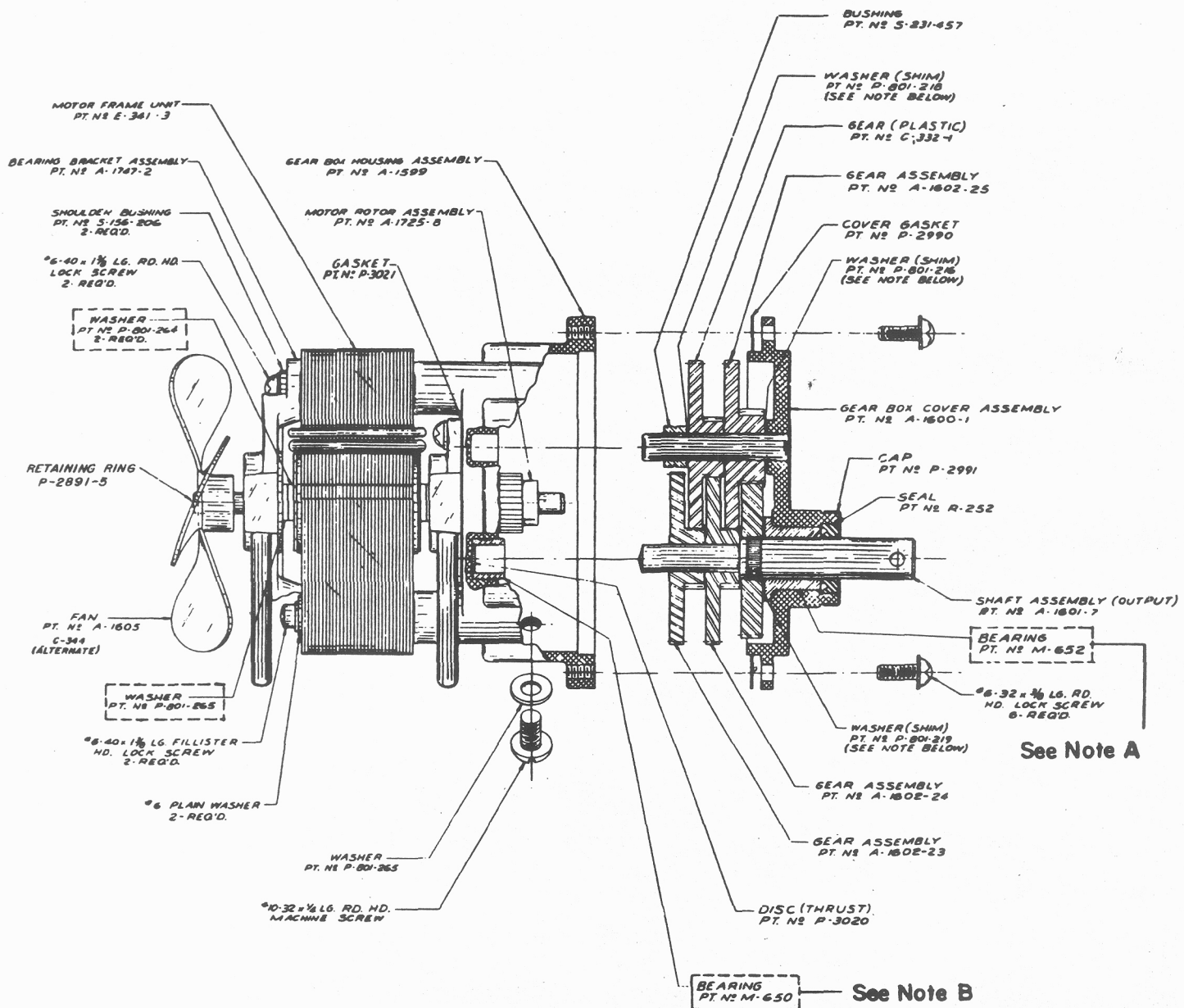

See Note A

See Note B

NOTE
 IN ORDER TO MAINTAIN PROPER CLEARANCES BETWEEN GEARS IT IS MOST IMPORTANT THAT WHEN REASSEMBLING GEAR TRAIN:
 1. SHIMS BE REPLACED IN THEIR RESPECTIVE LOCATIONS.
 2. SAME NUMBER OF SHIMS BE REPLACED IN EACH RESPECTIVE LOCATION.
 CHECK PART NUMBER ON GEAR BEFORE ORDERING GEAR

NOTE A: Bearing M-652 is part of Gear Box Cover Assembly A-1600-1 and cannot be ordered separately.

NOTE B: Bearing M-650 is part of Gear Box Housing Assembly A-1599 and cannot be ordered separately.

NEW ANTI-CHEAT COIN SWITCH CIRCUIT

The coin switch gives a very short pulse, when operated by a coin. With this new circuit, the game will tilt if the pulse is not as short as from a coin, so that operating the coin switch with wire, strings, etc., usually results in a tilt.

The circuit is completed thru control unit cam switch #4D (on wiring diagram at G-5).

MISCELLANEOUS PARTS

Back Cabinet Assembly:

Part No.	Name of Part
G-292-2	Back glass
M-281-14	Lock and keys (2) keyed alike
E-122-19	Transformer

Back Door Assembly:

M-281-24	Lock and Keys (2) keyed alike
SW-100-106	Lock switch
E-300-115	Search relay bank assembly

Front Cabinet Assembly:

M-168-15	Ball
AS-187-17	Ball shooter assembly
AS-1835	Ball shooter housing
A-100-7	Ball shooter rod
SP-200-24	Ball shooter spring (long)
SP-243	Ball shooter spring (short)
R-108-3	Ball shooter tip
P-711-1	Cigarette holder
P-1900-18	Coin box
A-1726	Coin box cover
E-130-10	Counter—48 volt
P-4052	Legs
M-106-1	Leg bolt
M-163-4	Leg adjuster
E-108-57	Toggle switch

Front Door Assembly:

Part No.	Name of Part
A-1538-3	Armature plate (AS-277-46)
A-1729-4	Button—metal
C-2342-102	Coil for coin kicker assembly
E-101-45	Coil for coin lock out
AS-1316	Coin kicker assembly
AS-277-46	Coin switch assembly 5¢
AS-277-47	Coin switch assembly 10¢
CA-567-76	Front door only
AS-1851	Front door assembly 5¢
AS-1851-1	Front door assembly 10¢
A-254-33	Hinge and bracket
M-281-6	Lock and keys
E-108-32	Micro switch for coin switch assembly 5¢ and 10¢ play
P-2768-5	Ring-red for A-1729-4 button
P-2768-6	Ring-yellow for A-1729-4 button
P-2768-7	Ring for M-281-6 lock
M-280-15	Slug rejector 5¢
M-280-16	Slug rejector 10¢

Front Moulding Assembly:

AS-1305-13	Front moulding assembly complete
A-1272-29	“R” Button
A-1272-30	Right Button
A-1272-31	Left Button
P-2210-8	5¢ Plate
P-2210-9	10¢ Plate
P-2210-63	Plate for Left & Right button
P-2210-38	Plate for “R” Button
CA-960-2	Front moulding only

Panel Assembly:

AS-1315	Ball gate and switch assembly
C-326-9	Light Shield post
R-115-4	Rebound rubber
M-170	Rebound spring-Double post
C-387-1	Roll over button—red
C-387-2	Roll over button—yellow
R-243	Rubber ring for Yellow post
R-243-2	Rubber ring for Red post

Bally pin game lubricant now available in one half-pint (8 Oz.)
containers with plastic spout and screw cap.

SEARCH POSITIONS CHART

	RED WIPER AT POSITION	WIPER (D) ROW 4 SEARCH RE. #1	WIPER (F) ROW 6 SEARCH RE. #2	WIPER (G) ROW 8 SEARCH RE. #3	WIPER (E) ROW 5 SEARCH RE. #4	WIPER (C) ROW 2 SEARCH RE. #5	WIPER (H) ROW 7 SEARCH RE. #6
GREEN SECTION	1	B2	B3	B4	C3	D3	D4
	2						
	3						
	4						
RED SUPER SECTION	5	A4	A5	B5	C4	C5	
	6						
	7						
	8						
YELLOW SECTION	9	D5	E4	E5	F5	G4	G5
	10						
	11						
	12						
YELLOW SUPER SECTION	13	A1	B1	C1	A2	A3	
	14						
	15						
	16						
RED SECTION	17	D1	E1	C2	D2	E2	F2
	18						
	19						
	20						
GREEN SECTION	21	F1	G1	G2	G3		
	22						
	23						
	24						
BLUE SECTION	25	E3	F3	F-4			
	26						
	27						
	28						
RED SECTION	29	H1	H2	H3	H4	H5	
	30						
	31						
	32						
	33						
	34						
	35						
	36						
YELLOW	VERTICAL	D	I	N	S	X	
	VERTICAL	A	F	K	P	U	
	HORIZONTAL	U	V	W	X	Y	
	HORIZONTAL	F	G	H	I	J	
RED	VERTICAL	E	J	O	T	Y	
	VERTICAL	B	G	L	Q	V	
	HORIZONTAL	P	Q	R	S	T	
	HORIZONTAL	A	B	C	D	E	
GREEN	DIAGONAL	E	I	M	Q	U	
	DIAGONAL	A	G	M	S	Y	
	HORIZONTAL	K	L	M	N	O	
	VERTICAL	C	H	M	R	W	
	49						
	50						

**MAGIC
SCREEN
POSITION**

Place colored reproduction of Magic Screen (FORM SEA ISLAND 1001-B) on top of number card (FORM SEA ISLAND 1001-A) so that dotted lines on colored form line up with dotted lines on card form. Then slide colored form left or right until MAGIC SCREEN POSITION arrow points to desired position (START, A, B, C, D, E, F, G, H). All search position information on colored form will then be in proper relation to score-numbers that you may wish to check by reference to SEARCH POSITION CHART and pictorial view of Search Disc (in manual).

H G F E D C B A START

9 1 2 11 15
4 19 7 22 18
25 24 16 13 17
6 23 5 21 20
12 8 14 3 10

CABINET

24		24	
20-2	71-2	13	48-2
25-8	78-7	14-5	50-2
27-8	80-2	15-6	54-5
30	81	18-6	63-2
36-15	85-13	21-3	70
40-7	90-5	27-2	71-6
48-4	91-7	31-4	75-14
50-5	93-7	36-3	80-6
52-9	98-11	38-3	85-7
53	40 P	41-4	90-9
54-11	90 P	43-2	91-1
57-14		45-3	93-4

TRANSFORMER

10	
20	81
30	20 P
54-2	40 P
70	50 P
80-1	90 P

PANEL

20		24		18	
14-3	60-1	10-10	57-1	13-12	50-5
25-1	61	14	61-4	14-12	52-1
31-1	71-1	15-6	63-1	15-12	56-1
36-3	74-1	18-3	65-1	20	61-1
40-8	75-14	21-3	70	27-1	65-2
43-1	78-3	30	71-8	31-4	91-4
45-8	81	36-1	75-1	38-1	20 P
51-1	85-3	40-1	80-6	41-8	70 P
53-1	90-1	41-4	85-5	48-1	
54-1	93-2	45-1	98-6		
		50-1			
		52-12			

DOOR

16	
13	50-2
14-5	63-2
18-6	70
21-3	71-2
25-8	85-7
27-8	90-9
40-7	93-4
48-2	

SEA ISLAND

623